

LAMPIRAN

BIODATA PENULIS



Nama : Siti Citra Camila
Tempat, Tanggal Lahir : Samarinda, 22 April 2001
Alamat Asal : Jalan Adam Malik Blok E No.36
Email : Siticitracamila@gmail.com
No. Telp : 0855-5115-1834

B. Riwayat Pendidikan

1. Tamat SD Tahun 2013 di SD Muhammadiyah 2 Samarinda
2. Tamat SMP Tahun 2016 di SMP Negeri 4 Samarinda
3. Tamat SMA Tahun 2019 di SMA Negeri 2 Samarinda

LEMBAR PENJELASAN RESPONDEN

Assalamualaikum wr.wb,

Saya yang bertanda tangan dibawah ini:

Nama Peneliti : Siti Citra Camila

NIM : 1911102411028

Saya adalah mahasiswa Universitas Muhammadiyah Kalimantan Timur jurusan Ilmu Keperawatan yang akan melakukan penelitian yang berjudul "Hubungan Dukungan Sosial Dengan Tingkat Ansietas Pada Mahasiswa Di Universitas Muhammadiyah Kalimantan Timur".

Dengan ini saya mengharapkan kesediaan Saudara/i untuk turut berpartisipasi dalam penelitian ini dengan menandatangani lembar persetujuan dan bersedia mengisi pernyataan dalam kuesioner.

Setiap pernyataan yang Saudara/i berikan mohon sesuai dengan kondisi Saudara/i saat ini, sehingga mencerminkan keadaan yang sebenarnya. Pernyataan yang berikan dijamin kerahasiaannya dan hanya akan digunakan untuk penelitian. Demikian saya sampaikan, atas perhatian dan partisipasi Saudara/i semua dalam membantu kelancaran penelitian ini, saya ucapkan terima kasih.

Peneliti

LEMBAR PERSETUJUAN RESPONDEN

Saya yang bertanda tangan di bawah ini :

Kode responden (diisi oleh peneliti) :

Setelah mendapat penjelasan, saya bersedia bersedia berpartisipasi sebagai responden penelitian dengan judul “Hubungan Dukungan Sosial Dengan Tingkat Ansietas Pada Mahasiswa Di Universitas Muhammadiyah Kalimantan Timur”.

Nama : Siti Citra Camila

NIM : 1911102411028

Saya mengerti bahwa penelitian ini tidak akan berakibat negatif pada saya dan segala informasi yang saya berikan akan dijamin kerahasiaannya karena itu jawaban yang saya berikan adalah yang sebenar – benarnya.

Berdasarkan semua penjelasan diatas, maka dengan ini saya menyatakan secara sukarela bersedia dan berpartisipasi aktif di dalam penelitian ini.

Samarinda, 2022

(Responden)



Identitas Responden

Petunjuk Pengisian :

Mohon saudara/i untuk mengisi pertanyaan yang telah disediakan dan berilah tanda ceklis (√) pada salah satu pilihan yang sesuai

Usia : tahun

Jenis Kelamin : Perempuan

Laki-laki

Program Studi : S1 Keperawatan

D3 Keperawatan

S1 Kesehatan Lingkungan

D3 Kesehatan Lingkungan

S1 Farmasi

S1 Hubungan Internasional

S1 Hukum

S1 Kesehatan Masyarakat

- S1 Manajemen
- S1 Pendidikan Bahasa Inggris
- S1 Pendidikan Olahraga
- S1 Psikolog
- S1 Teknik Geologi
- S1 Teknik Informatika
- S1 Teknik Mesin
- S1 Teknik Sipil
- S1 Akuntansi
- Alih Jenjang
- Ners
- Vokasi Kelas Mekanik Alat Berat
- Vokasi Operator

Tempat Tinggal : Keluarga

Orang Tua

Kos

Kontrak

Pernah Berkuliah : Tidak

Ya

**Kuesioner Multidimensional Scale of Perceived Social Support
(MSPSS)**

Petunjuk Pengisian Kuesioner

Beri tanda (o) pada salah satu alternatif jawaban yang anda anggap sesuai dengan diri anda. Setiap orang memiliki jawaban yang berbeda. Tidak ada yang benar dan salah, semua hanya untuk kepentingan penelitian. Periksalah kembali jawaban saudara/i, jangan sampai ada pertanyaan yang tidak terjawab.

Keterangan Jawaban

- 1 = Sangat Tidak Sesuai
- 2 = Tidak Sesuai
- 3 = Agak Tidak Sesuai
- 4 = Netral
- 5 = Agak Sesuai
- 6 = Sesuai
- 7 = Sangat Sesuai

No	Pernyataan	Jawaban						
		1	2	3	4	5	6	7
1	Keluarga saya sungguh-sungguh berusaha membantu saya							
2	Saya mendapatkan bantuan emosional dan dukungan yang saya butuhkan dari keluarga saya							
3	Saya dapat membicarakan masalah-masalah saya dengan keluarga saya							
4	Keluarga saya bersedia untuk membantu saya dalam mengambil keputusan							
5	Teman-teman saya sungguh-sungguh berusaha membantu saya							
6	Saya dapat mengandalkan teman-teman saya ketika sesuatu berjalan tidak seperti yang seharusnya							
7	Saya memiliki teman-teman untuk berbagi suka dan duka							
8	Saya dapat membicarakan masalah-masalah saya dengan teman-teman saya							
9	Ada seseorang yang spesial di sekitar saya ketika saya membutuhkan							

10	Ada seseorang yang menjadi tempat saya berbagi suka dan duka	1	2	3	4	5	6	7
11	Saya memiliki seseorang yang spesial yang menjadi sumber nyata kenyamanan bagi saya	1	2	3	4	5	6	7
12	Ada seseorang spesial dalam kehidupan saya yang peduli dengan perasaan-perasaan saya.	1	2	3	4	5	6	7

Kuesioner State Anxiety Inventory (SAI)

Petunjuk Pengisian Kuesioner

Bacalah masing-masing kalimat di bawah ini dan berikan tanda ceklis (✓) pada respon yang tepat yang menunjukkan apa yang Anda rasakan sekarang, pada saat ini. Tidak ada jawaban yang benar atau salah. Jangan berpikir terlalu lama dalam menjawab setiap pernyataan tapi berikan jawaban yang paling menggambarkan perasaan Anda saat ini.

No	Pernyataan	Sama Sekali Tidak Merasakan (1)	Sedikit Merasakan (2)	Lumayan Merasakan (3)	Sangat Merasakan (4)
1	Saya merasa tenang				
2	saya merasa aman				
3	Tubuh saya merasa tegang				
4	Saya merasa tertekan				

5	Saya merasa tentram				
6	Saya merasa kesal /marah				
7	Saya sekarang merasa khawatir dengan kemungkinan tidak beruntung				
8	Saya merasa lega				
9	Saya merasa takut				
10	Saya merasa nyaman				
11	Saya merasakan kepercayaan diri				
12	Saya merasa gugup				
13	Saya merasa gelisah				

14	Saya merasa bimbang				
15	Saya merasa santai				
16	Saya merasakan kepuasan				
17	Saya khawatir				
18	Saya merasa bingung				
19	Saya merasa mantap/yakin				
20	Saya merasa senang				

Data Karakteristik Responden

Nomor Responden	Usia	Jenis Kelamin	Program Studi	Tempat Tinggal	Riwayat Berkuliah
1	22	Perempuan	S1 Keperawatan	Kontrak	Tidak
2	21	Laki-Laki	S1 Keperawatan	Kontrak	Ya
3	22	Laki-Laki	S1 Keperawatan	Kontrak	Ya
4	18	Perempuan	S1 Keperawatan	Kos	Tidak
5	19	Perempuan	S1 Keperawatan	Orang Tua	Tidak
6	18	Perempuan	S1 Keperawatan	Kos	Tidak
7	18	Perempuan	S1 Keperawatan	Kos	Tidak
8	18	Perempuan	S1 Keperawatan	Orang Tua	Tidak
9	18	Perempuan	S1 Keperawatan	Kos	Tidak
10	18	Perempuan	S1 Keperawatan	Kos	Tidak
11	18	Perempuan	S1 Keperawatan	Keluarga	Tidak
12	18	Perempuan	S1 Keperawatan	Kos	Tidak
13	18	Perempuan	S1 Keperawatan	Kos	Tidak
14	19	Perempuan	S1 Keperawatan	Kos	Tidak
15	18	Perempuan	S1 Keperawatan	Kos	Tidak
16	18	Laki-Laki	S1 Keperawatan	Orang Tua	Tidak
17	18	Perempuan	S1 Keperawatan	Kos	Tidak
18	19	Perempuan	S1 Keperawatan	Orang Tua	Tidak
19	17	Laki-Laki	S1 Keperawatan	Orang Tua	Tidak
20	18	Perempuan	S1 Keperawatan	Keluarga	Tidak
21	18	Perempuan	S1 Keperawatan	Keluarga	Tidak
22	19	Laki-Laki	S1 Keperawatan	Kos	Tidak
23	18	Perempuan	S1 Keperawatan	Keluarga	Tidak

24	17	Laki-Laki	S1 Keperawatan	Orang Tua	Tidak
25	17	Perempuan	S1 Keperawatan	Kos	Tidak
26	19	Perempuan	S1 Keperawatan	Orang Tua	Tidak
27	17	Perempuan	S1 Keperawatan	Orang Tua	Tidak
28	18	Perempuan	S1 Keperawatan	Keluarga	Tidak
29	18	Perempuan	S1 Keperawatan	Kos	Tidak
30	18	Perempuan	S1 Keperawatan	Kos	Tidak
31	18	Perempuan	S1 Keperawatan	Kos	Tidak
32	18	Perempuan	S1 Keperawatan	Orang Tua	Tidak
33	20	Perempuan	S1 Keperawatan	Keluarga	Tidak
34	18	Perempuan	S1 Keperawatan	Orang Tua	Tidak
35	18	Perempuan	S1 Keperawatan	Kos	Tidak
36	18	Perempuan	S1 Keperawatan	Kos	Tidak
37	18	Perempuan	S1 Keperawatan	Kos	Tidak
38	19	Perempuan	S1 Keperawatan	Kos	Tidak
39	18	Perempuan	S1 Keperawatan	Keluarga	Tidak
40	18	Perempuan	S1 Keperawatan	Kos	Tidak
41	18	Laki-Laki	S1 Keperawatan	Orang Tua	Tidak
42	21	Laki-Laki	S1 Keperawatan	Kos	Tidak
43	18	Perempuan	S1 Keperawatan	Kos	Tidak
44	18	Perempuan	S1 Keperawatan	Kos	Tidak
45	18	Perempuan	S1 Keperawatan	Keluarga	Tidak
46	18	Perempuan	D3 Keperawatan	Kos	Tidak
47	18	Perempuan	D3 Keperawatan	Orang Tua	Tidak

48	17	Perempuan	D3 Keperawatan	Orang Tua	Tidak
49	18	Perempuan	D3 Keperawatan	Orang Tua	Tidak
50	18	Perempuan	D3 Keperawatan	Kos	Tidak
51	18	Perempuan	D3 Keperawatan	Kos	Tidak
52	18	Perempuan	D3 Keperawatan	Kos	Tidak
53	18	Perempuan	D3 Keperawatan	Kos	Tidak
54	18	Perempuan	D3 Keperawatan	Kos	Tidak
55	18	Perempuan	D3 Keperawatan	Orang Tua	Tidak
56	18	Perempuan	D3 Keperawatan	Kos	Tidak
57	18	Perempuan	D3 Keperawatan	Kos	Tidak
58	18	Perempuan	D3 Keperawatan	Orang Tua	Tidak
59	17	Laki-Laki	D3 Keperawatan	Kos	Tidak
60	18	Laki-Laki	D3 Keperawatan	Keluarga	Tidak
61	19	Laki-Laki	D3 Keperawatan	Orang Tua	Tidak
62	18	Perempuan	D3 Keperawatan	Kos	Tidak
63	18	Perempuan	D3 Keperawatan	Keluarga	Tidak
64	18	Perempuan	D3 Keperawatan	Kos	Tidak
65	18	Perempuan	D3 Keperawatan	Kos	Tidak
66	18	Perempuan	D3 Keperawatan	Kos	Tidak
67	18	Perempuan	D3 Keperawatan	Kos	Tidak
68	18	Perempuan	D3 Keperawatan	Kos	Tidak
69	17	Perempuan	D3 Keperawatan	Kos	Tidak
70	18	Perempuan	D3 Keperawatan	Kos	Tidak
71	22	Perempuan	D3 Keperawatan	Kontrak	Tidak

72	18	Perempuan	D3 Keperawatan	Kos	Tidak
73	18	Perempuan	D3 Keperawatan	Orang Tua	Tidak
74	18	Perempuan	D3 Keperawatan	Kos	Tidak
75	17	Perempuan	D3 Keperawatan	Keluarga	Tidak
76	18	Perempuan	D3 Keperawatan	Keluarga	Tidak
77	20	Perempuan	D3 Keperawatan	Kos	Tidak
78	21	Laki-Laki	D3 Keperawatan	Orang Tua	Tidak
79	18	Laki-Laki	D3 Keperawatan	Kontrak	Tidak
80	18	Laki-Laki	D3 Keperawatan	Kontrak	Tidak
81	19	Perempuan	D3 Keperawatan	Kos	Tidak
82	20	Perempuan	D3 Kesehatan Lingkungan	Kos	Tidak
83	18	Perempuan	D3 Kesehatan Lingkungan	Orang Tua	Tidak
84	18	Perempuan	D3 Kesehatan Lingkungan	Kos	Tidak
85	18	Perempuan	D3 Kesehatan Lingkungan	Kos	Tidak
86	17	Perempuan	D3 Kesehatan Lingkungan	Keluarga	Tidak
87	18	Perempuan	D3 Kesehatan Lingkungan	Keluarga	Tidak
88	18	Perempuan	D3 Kesehatan Lingkungan	Kos	Tidak
89	17	Laki-Laki	D3 Kesehatan Lingkungan	Kos	Tidak
90	18	Perempuan	D3 Kesehatan Lingkungan	Kontrak	Tidak
91	18	Perempuan	D3 Kesehatan Lingkungan	Orang Tua	Tidak
92	19	Perempuan	S1 Kesehatan Lingkungan	Kos	Tidak
93	18	Laki-Laki	S1 Kesehatan Lingkungan	Orang Tua	Tidak
94	18	Perempuan	S1 Kesehatan Lingkungan	Orang Tua	Tidak
95	18	Perempuan	S1 Kesehatan Lingkungan	Kos	Tidak

96	19	Perempuan	S1 Kesehatan Lingkungan	Keluarga	Tidak
97	17	Perempuan	S1 Kesehatan Lingkungan	Orang Tua	Tidak
98	18	Laki-Laki	S1 Kesehatan Lingkungan	Kos	Tidak
99	18	Perempuan	S1 Kesehatan Lingkungan	Orang Tua	Tidak
100	19	Perempuan	S1 Kesehatan Lingkungan	Keluarga	Tidak
101	19	Perempuan	S1 Kesehatan Lingkungan	Kos	Tidak
102	18	Perempuan	S1 Kesehatan Lingkungan	Kos	Tidak
103	17	Perempuan	S1 Kesehatan Lingkungan	Orang Tua	Tidak
104	18	Laki-Laki	S1 Kesehatan Lingkungan	Kos	Tidak
105	21	Perempuan	S1 Kesehatan Lingkungan	Orang Tua	Tidak
106	18	Perempuan	S1 Kesehatan Lingkungan	Kos	Tidak
107	18	Perempuan	S1 Kesehatan Lingkungan	Orang Tua	Tidak
108	17	Laki-Laki	S1 Kesehatan Lingkungan	Orang Tua	Tidak
109	19	Laki-Laki	S1 Kesehatan Lingkungan	Kos	Tidak
110	19	Perempuan	S1 Farmasi	Orang Tua	Tidak
111	18	Perempuan	S1 Farmasi	Kos	Tidak
112	19	Perempuan	S1 Farmasi	Keluarga	Tidak
113	18	Perempuan	S1 Farmasi	Orang Tua	Tidak
114	19	Perempuan	S1 Farmasi	Kontrak	Tidak
115	18	Perempuan	S1 Farmasi	Kos	Tidak
116	19	Perempuan	S1 Farmasi	Kos	Tidak
117	18	Perempuan	S1 Farmasi	Kos	Tidak
118	17	Perempuan	S1 Farmasi	Kos	Tidak

119	19	Perempuan	S1 Farmasi	Keluarga	Tidak
120	18	Perempuan	S1 Farmasi	Kos	Tidak
121	17	Laki-Laki	S1 Farmasi	Kontrak	Tidak
122	18	Perempuan	S1 Farmasi	Kos	Tidak
123	19	Laki-Laki	S1 Farmasi	Kos	Tidak
124	17	Perempuan	S1 Farmasi	Orang Tua	Tidak
125	18	Perempuan	S1 Farmasi	Kontrak	Tidak
126	18	Perempuan	S1 Farmasi	Kos	Tidak
127	19	Perempuan	S1 Farmasi	Kos	Tidak
128	18	Perempuan	S1 Farmasi	Orang Tua	Tidak
129	18	Perempuan	S1 Farmasi	Kos	Tidak
130	18	Perempuan	S1 Farmasi	Kos	Tidak
131	18	Perempuan	S1 Farmasi	Kos	Tidak
132	19	Perempuan	S1 Farmasi	Kos	Tidak
133	18	Perempuan	S1 Farmasi	Kontrak	Tidak
134	18	Perempuan	S1 Farmasi	Orang Tua	Tidak
135	17	Perempuan	S1 Farmasi	Orang Tua	Tidak
136	18	Perempuan	S1 Farmasi	Kos	Tidak
137	17	Perempuan	S1 Farmasi	Orang Tua	Tidak
138	18	Laki-Laki	S1 Farmasi	Kos	Tidak
139	18	Perempuan	S1 Farmasi	Orang Tua	Tidak
140	18	Perempuan	S1 Farmasi	Orang Tua	Tidak
141	18	Perempuan	S1 Farmasi	Kos	Tidak
142	18	Perempuan	S1 Farmasi	Kos	Tidak

143	19	Perempuan	S1 Farmasi	Kos	Tidak
144	18	Laki-Laki	S1 Farmasi	Orang Tua	Tidak
145	18	Perempuan	S1 Farmasi	Kos	Tidak
146	18	Perempuan	S1 Farmasi	Kos	Tidak
147	19	Perempuan	S1 Farmasi	Orang Tua	Tidak
148	17	Perempuan	S1 Farmasi	Kos	Tidak
149	18	Perempuan	S1 Farmasi	Kos	Tidak
150	19	Perempuan	S1 Farmasi	Kontrak	Tidak
151	19	Perempuan	S1 Farmasi	Keluarga	Tidak
152	18	Perempuan	S1 Farmasi	Kos	Tidak
153	18	Perempuan	S1 Farmasi	Keluarga	Tidak
154	18	Perempuan	S1 Farmasi	Kos	Tidak
155	19	Perempuan	S1 Farmasi	Kos	Tidak
156	18	Perempuan	S1 Farmasi	Orang Tua	Tidak
157	17	Perempuan	S1 Farmasi	Kos	Tidak
158	18	Perempuan	S1 Farmasi	Kos	Tidak
159	18	Perempuan	S1 Farmasi	Keluarga	Tidak
160	17	Perempuan	S1 Hubungan Internasional	Keluarga	Tidak
161	19	Perempuan	S1 Hubungan Internasional	Kos	Tidak
162	19	Perempuan	S1 Hubungan Internasional	Kos	Tidak
163	18	Laki-Laki	S1 Hubungan Internasional	Orang Tua	Tidak
164	18	Laki-Laki	S1 Hubungan Internasional	Keluarga	Tidak
165	19	Perempuan	S1 Hubungan Internasional	Kos	Tidak

166	18	Perempuan	S1 Hubungan Internasional	Keluarga	Tidak
167	18	Laki-Laki	S1 Hubungan Internasional	Kos	Tidak
168	19	Perempuan	S1 Hubungan Internasional	Orang Tua	Tidak
169	19	Perempuan	S1 Hubungan Internasional	Keluarga	Tidak
170	18	Laki-Laki	S1 Hubungan Internasional	Keluarga	Tidak
171	20	Perempuan	S1 Hubungan Internasional	Orang Tua	Tidak
172	18	Perempuan	S1 Hubungan Internasional	Kos	Tidak
173	17	Perempuan	S1 Hubungan Internasional	Orang Tua	Tidak
174	18	Perempuan	S1 Hubungan Internasional	Orang Tua	Tidak
175	18	Perempuan	S1 Hubungan Internasional	Orang Tua	Tidak
176	18	Perempuan	S1 Hubungan Internasional	Kos	Tidak
177	19	Perempuan	S1 Hubungan Internasional	Kos	Tidak
178	19	Perempuan	S1 Hubungan Internasional	Orang Tua	Tidak
179	18	Perempuan	S1 Hubungan Internasional	Orang Tua	Tidak
180	19	Perempuan	S1 Hubungan Internasional	Keluarga	Tidak
181	18	Perempuan	S1 Hubungan Internasional	Orang Tua	Tidak
182	18	Perempuan	S1 Hubungan Internasional	Kos	Tidak
183	19	Perempuan	S1 Hubungan Internasional	Kos	Tidak
184	19	Perempuan	S1 Hubungan Internasional	Kos	Tidak
185	18	Perempuan	S1 Hubungan Internasional	Orang Tua	Tidak
186	19	Perempuan	S1 Hubungan Internasional	Kos	Tidak
187	19	Perempuan	S1 Hubungan Internasional	Keluarga	Tidak
188	18	Perempuan	S1 Hubungan Internasional	Keluarga	Tidak

189	18	Perempuan	S1 Hubungan Internasional	Orang Tua	Tidak
190	18	Laki-Laki	S1 Hukum	Orang Tua	Tidak
191	18	Perempuan	S1 Hukum	Keluarga	Tidak
192	18	Perempuan	S1 Hukum	Orang Tua	Tidak
193	18	Perempuan	S1 Hukum	Orang Tua	Tidak
194	17	Perempuan	S1 Hukum	Keluarga	Tidak
195	18	Perempuan	S1 Hukum	Orang Tua	Tidak
196	18	Perempuan	S1 Hukum	Orang Tua	Tidak
197	19	Perempuan	S1 Hukum	Keluarga	Tidak
198	18	Perempuan	S1 Hukum	Kos	Tidak
199	20	Laki-Laki	S1 Hukum	Kos	Tidak
200	19	Perempuan	S1 Hukum	Orang Tua	Tidak
201	18	Perempuan	S1 Hukum	Kos	Tidak
202	17	Laki-Laki	S1 Hukum	Kos	Tidak
203	18	Laki-Laki	S1 Hukum	Orang Tua	Tidak
204	21	Perempuan	S1 Hukum	Keluarga	Tidak
205	18	Perempuan	S1 Hukum	Orang Tua	Tidak
206	18	Perempuan	S1 Hukum	Kos	Tidak
207	19	Perempuan	S1 Hukum	Kos	Tidak
208	18	Perempuan	S1 Hukum	Orang Tua	Tidak
209	18	Perempuan	S1 Hukum	Kos	Tidak
210	18	Laki-Laki	S1 Hukum	Orang Tua	Tidak
211	20	Laki-Laki	S1 Hukum	Orang Tua	Tidak
212	18	Laki-Laki	S1 Hukum	Kos	Tidak
213	19	Laki-Laki	S1 Hukum	Orang Tua	Tidak
214	19	Laki-Laki	S1 Hukum	Kos	Tidak
215	17	Perempuan	S1 Hukum	Orang Tua	Tidak

216	18	Perempuan	S1 Hukum	Orang Tua	Tidak
217	18	Perempuan	S1 Hukum	Kontrak	Tidak
218	19	Laki-Laki	S1 Hukum	Keluarga	Tidak
219	19	Perempuan	S1 Hukum	Kos	Tidak
220	19	Perempuan	S1 Hukum	Kontrak	Tidak
221	17	Perempuan	S1 Hukum	Kos	Tidak
222	18	Laki-Laki	S1 Hukum	Orang Tua	Tidak
223	18	Perempuan	S1 Hukum	Kos	Tidak
224	19	Perempuan	S1 Hukum	Orang Tua	Tidak
225	18	Perempuan	S1 Hukum	Keluarga	Tidak
226	18	Perempuan	S1 Hukum	Orang Tua	Tidak
227	18	Perempuan	S1 Hukum	Keluarga	Tidak
228	18	Perempuan	S1 Hukum	Kos	Tidak
229	18	Laki-Laki	S1 Hukum	Kos	Tidak
230	19	Perempuan	S1 Hukum	Kos	Tidak
231	18	Laki-Laki	S1 Hukum	Orang Tua	Tidak
232	18	Perempuan	S1 Hukum	Orang Tua	Tidak
233	18	Perempuan	S1 Hukum	Kos	Tidak
234	19	Perempuan	S1 Hukum	Kos	Tidak
235	18	Perempuan	S1 Hukum	Orang Tua	Tidak
236	18	Perempuan	S1 Hukum	Keluarga	Tidak
237	18	Perempuan	S1 Hukum	Orang Tua	Tidak
238	18	Perempuan	S1 Hukum	Keluarga	Tidak
239	19	Perempuan	S1 Hukum	Orang Tua	Tidak
240	18	Laki-Laki	S1 Hukum	Orang Tua	Tidak
241	20	Laki-Laki	S1 Hukum	Orang Tua	Tidak

242	18	Perempuan	S1 Hukum	Orang Tua	Tidak
243	19	Perempuan	S1 Hukum	Keluarga	Tidak
244	19	Laki-Laki	S1 Hukum	Kos	Tidak
245	18	Perempuan	S1 Hukum	Kos	Tidak
246	19	Perempuan	S1 Hukum	Kos	Tidak
247	19	Laki-Laki	S1 Hukum	Orang Tua	Tidak
248	20	Laki-Laki	S1 Hukum	Kos	Tidak
249	18	Laki-Laki	S1 Hukum	Keluarga	Tidak
250	19	Perempuan	S1 Hukum	Kos	Tidak
251	18	Perempuan	S1 Hukum	Kos	Tidak
252	18	Perempuan	S1 Hukum	Kos	Tidak
253	18	Perempuan	S1 Kesehatan Masyarakat	Kos	Tidak
254	18	Perempuan	S1 Kesehatan Masyarakat	Kos	Tidak
255	19	Laki-Laki	S1 Kesehatan Masyarakat	Orang Tua	Tidak
256	18	Perempuan	S1 Kesehatan Masyarakat	Kos	Tidak
257	18	Perempuan	S1 Kesehatan Masyarakat	Orang Tua	Tidak
258	19	Perempuan	S1 Kesehatan Masyarakat	Orang Tua	Tidak
259	19	Laki-Laki	S1 Kesehatan Masyarakat	Kontrak	Tidak
260	18	Perempuan	S1 Kesehatan Masyarakat	Kos	Tidak
261	18	Laki-Laki	S1 Kesehatan Masyarakat	Keluarga	Tidak
262	18	Perempuan	S1 Kesehatan Masyarakat	Kos	Tidak
263	18	Perempuan	S1 Kesehatan Masyarakat	Kos	Tidak
264	20	Perempuan	S1 Kesehatan Masyarakat	Kos	Tidak
265	18	Perempuan	S1 Kesehatan Masyarakat	Orang Tua	Tidak
266	19	Perempuan	S1 Kesehatan Masyarakat	Kontrak	Tidak

267	17	Perempuan	S1 Kesehatan Masyarakat	Keluarga	Tidak
268	18	Perempuan	S1 Kesehatan Masyarakat	Kos	Tidak
269	18	Perempuan	S1 Kesehatan Masyarakat	Kos	Tidak
270	19	Laki-Laki	S1 Kesehatan Masyarakat	Orang Tua	Tidak
271	17	Perempuan	S1 Kesehatan Masyarakat	Kos	Tidak
272	19	Perempuan	S1 Kesehatan Masyarakat	Keluarga	Tidak
273	18	Perempuan	S1 Kesehatan Masyarakat	Kontrak	Tidak
274	18	Perempuan	S1 Kesehatan Masyarakat	Kontrak	Tidak
275	18	Perempuan	S1 Kesehatan Masyarakat	Kos	Tidak
276	19	Perempuan	S1 Kesehatan Masyarakat	Orang Tua	Tidak
277	17	Perempuan	S1 Kesehatan Masyarakat	Kos	Tidak
278	18	Perempuan	S1 Kesehatan Masyarakat	Orang Tua	Tidak
279	19	Perempuan	S1 Kesehatan Masyarakat	Kos	Tidak
280	18	Perempuan	S1 Kesehatan Masyarakat	Keluarga	Tidak
281	20	Perempuan	S1 Kesehatan Masyarakat	Kos	Tidak
282	19	Perempuan	S1 Kesehatan Masyarakat	Orang Tua	Tidak
283	18	Laki-Laki	S1 Kesehatan Masyarakat	Orang Tua	Tidak
284	18	Perempuan	S1 Kesehatan Masyarakat	Kos	Tidak
285	19	Laki-Laki	S1 Kesehatan Masyarakat	Kos	Tidak
286	17	Perempuan	S1 Kesehatan Masyarakat	Kos	Tidak
287	18	Perempuan	S1 Kesehatan Masyarakat	Kos	Tidak
288	18	Laki-Laki	S1 Kesehatan Masyarakat	Orang Tua	Tidak
289	19	Perempuan	S1 Kesehatan Masyarakat	Kos	Tidak

290	18	Perempuan	S1 Kesehatan Masyarakat	Orang Tua	Tidak
291	18	Laki-Laki	S1 Kesehatan Masyarakat	Kos	Tidak
292	18	Perempuan	S1 Kesehatan Masyarakat	Orang Tua	Tidak
293	22	Perempuan	S1 Kesehatan Masyarakat	Kos	Tidak
294	17	Perempuan	S1 Kesehatan Masyarakat	Kos	Tidak
295	18	Perempuan	S1 Kesehatan Masyarakat	Kos	Tidak
296	18	Laki-Laki	S1 Kesehatan Masyarakat	Kontrak	Tidak
297	17	Perempuan	S1 Kesehatan Masyarakat	Kos	Tidak
298	18	Perempuan	S1 Kesehatan Masyarakat	Orang Tua	Tidak
299	18	Perempuan	S1 Kesehatan Masyarakat	Kos	Tidak
300	18	Perempuan	S1 Kesehatan Masyarakat	Kos	Tidak
301	19	Laki-Laki	S1 Kesehatan Masyarakat	Keluarga	Tidak
302	18	Perempuan	S1 Kesehatan Masyarakat	Kos	Tidak
303	18	Laki-Laki	S1 Kesehatan Masyarakat	Orang Tua	Tidak
304	20	Laki-Laki	S1 Kesehatan Masyarakat	Kos	Tidak
305	18	Perempuan	S1 Kesehatan Masyarakat	Orang Tua	Tidak
306	19	Perempuan	S1 Kesehatan Masyarakat	Orang Tua	Tidak
307	18	Perempuan	S1 Kesehatan Masyarakat	Kos	Tidak
308	18	Perempuan	S1 Kesehatan Masyarakat	Orang Tua	Tidak
309	20	Perempuan	S1 Kesehatan Masyarakat	Keluarga	Tidak
310	19	Perempuan	S1 Kesehatan Masyarakat	Kos	Tidak
311	20	Perempuan	S1 Kesehatan Masyarakat	Kos	Tidak
312	19	Laki-Laki	S1 Kesehatan Masyarakat	Keluarga	Tidak

313	18	Perempuan	S1 Kesehatan Masyarakat	Kos	Tidak
314	18	Perempuan	S1 Kesehatan Masyarakat	Kos	Tidak
315	18	Laki-Laki	S1 Kesehatan Masyarakat	Orang Tua	Tidak
316	18	Laki-Laki	S1 Kesehatan Masyarakat	Kos	Tidak
317	21	Laki-Laki	S1 Kesehatan Masyarakat	Orang Tua	Tidak
318	18	Perempuan	S1 Kesehatan Masyarakat	Orang Tua	Tidak
319	19	Perempuan	S1 Kesehatan Masyarakat	Kos	Tidak
320	20	Perempuan	S1 Kesehatan Masyarakat	Kos	Tidak
321	18	Perempuan	S1 Kesehatan Masyarakat	Kos	Tidak
322	18	Laki-Laki	S1 Kesehatan Masyarakat	Kos	Tidak
323	17	Perempuan	S1 Kesehatan Masyarakat	Kos	Tidak
324	18	Perempuan	S1 Kesehatan Masyarakat	Keluarga	Tidak
325	19	Perempuan	S1 Kesehatan Masyarakat	Keluarga	Tidak
326	21	Perempuan	S1 Manajemen	Orang Tua	Tidak
327	28	Laki-Laki	S1 Manajemen	Orang Tua	Tidak
328	18	Perempuan	S1 Manajemen	Orang Tua	Tidak
329	19	Laki-Laki	S1 Manajemen	Kos	Tidak
330	19	Laki-Laki	S1 Manajemen	Kos	Tidak
331	23	Laki-Laki	S1 Manajemen	Keluarga	Tidak
332	20	Laki-Laki	S1 Manajemen	Orang Tua	Tidak
333	22	Laki-Laki	S1 Manajemen	Keluarga	Tidak
334	18	Perempuan	S1 Manajemen	Kos	Tidak
335	18	Perempuan	S1 Manajemen	Keluarga	Tidak
336	26	Laki-Laki	S1 Manajemen	Kontrak	Tidak
337	22	Perempuan	S1 Manajemen	Orang Tua	Tidak
338	21	Laki-Laki	S1 Manajemen	Orang Tua	Tidak
339	20	Laki-Laki	S1 Manajemen	Orang Tua	Tidak

340	18	Perempuan	S1 Manajemen	Orang Tua	Tidak
341	17	Perempuan	S1 Manajemen	Orang Tua	Tidak
342	22	Laki-Laki	S1 Manajemen	Orang Tua	Tidak
343	24	Laki-Laki	S1 Manajemen	Keluarga	Tidak
344	17	Perempuan	S1 Manajemen	Kos	Tidak
345	19	Perempuan	S1 Manajemen	Kos	Tidak
346	19	Perempuan	S1 Manajemen	Kos	Tidak
347	21	Perempuan	S1 Manajemen	Orang Tua	Tidak
348	18	Perempuan	S1 Manajemen	Orang Tua	Tidak
349	19	Laki-Laki	S1 Manajemen	Kos	Tidak
350	18	Perempuan	S1 Manajemen	Kos	Tidak
351	18	Perempuan	S1 Manajemen	Orang Tua	Tidak
352	18	Perempuan	S1 Manajemen	Orang Tua	Tidak
353	19	Perempuan	S1 Manajemen	Kontrak	Tidak
354	18	Perempuan	S1 Manajemen	Orang Tua	Tidak
355	18	Perempuan	S1 Manajemen	Keluarga	Tidak
356	18	Laki-Laki	S1 Manajemen	Kos	Tidak
357	18	Perempuan	S1 Manajemen	Orang Tua	Tidak
358	18	Perempuan	S1 Manajemen	Kos	Tidak
359	17	Perempuan	S1 Manajemen	Keluarga	Tidak
360	18	Perempuan	S1 Manajemen	Kos	Tidak
361	20	Laki-Laki	S1 Manajemen	Kos	Tidak
362	18	Perempuan	S1 Manajemen	Kontrak	Tidak
363	18	Perempuan	S1 Manajemen	Orang Tua	Tidak
364	18	Perempuan	S1 Manajemen	Keluarga	Tidak
365	20	Laki-Laki	S1 Manajemen	Orang Tua	Tidak

366	19	Perempuan	S1 Manajemen	Orang Tua	Tidak
367	18	Perempuan	S1 Manajemen	Kos	Tidak
368	18	Perempuan	S1 Manajemen	Keluarga	Tidak
369	20	Perempuan	S1 Manajemen	Keluarga	Tidak
370	18	Perempuan	S1 Manajemen	Orang Tua	Tidak
371	18	Perempuan	S1 Manajemen	Kos	Tidak
372	21	Perempuan	S1 Manajemen	Kos	Tidak
373	18	Perempuan	S1 Manajemen	Orang Tua	Tidak
374	18	Perempuan	S1 Manajemen	Kontrak	Tidak
375	18	Laki-Laki	S1 Manajemen	Keluarga	Tidak
376	19	Perempuan	S1 Manajemen	Kos	Tidak
377	18	Perempuan	S1 Manajemen	Orang Tua	Tidak
378	20	Perempuan	S1 Manajemen	Orang Tua	Tidak
379	19	Laki-Laki	S1 Manajemen	Orang Tua	Tidak
380	18	Laki-Laki	S1 Manajemen	Kos	Tidak
381	18	Perempuan	S1 Manajemen	Orang Tua	Tidak
382	19	Laki-Laki	S1 Manajemen	Orang Tua	Tidak
383	18	Perempuan	S1 Manajemen	Orang Tua	Tidak
384	18	Perempuan	S1 Manajemen	Kos	Tidak
385	18	Laki-Laki	S1 Manajemen	Keluarga	Tidak
386	20	Laki-Laki	S1 Manajemen	Kos	Tidak
387	18	Perempuan	S1 Manajemen	Orang Tua	Tidak
388	20	Perempuan	S1 Manajemen	Orang Tua	Tidak
389	18	Perempuan	S1 Manajemen	Kos	Tidak
390	18	Perempuan	S1 Manajemen	Orang Tua	Tidak
391	18	Perempuan	S1 Manajemen	Keluarga	Tidak

392	18	Perempuan	S1 Manajemen	Orang Tua	Tidak
393	18	Laki-Laki	S1 Manajemen	Kos	Tidak
394	18	Perempuan	S1 Manajemen	Kos	Tidak
395	18	Perempuan	S1 Manajemen	Kos	Tidak
396	21	Laki-Laki	S1 Manajemen	Orang Tua	Tidak
397	18	Laki-Laki	S1 Manajemen	Kontrak	Tidak
398	18	Laki-Laki	S1 Manajemen	Kontrak	Tidak
399	20	Perempuan	S1 Manajemen	Kos	Tidak
400	17	Perempuan	S1 Manajemen	Kos	Tidak
401	19	Laki-Laki	S1 Manajemen	Keluarga	Tidak
402	19	Perempuan	S1 Manajemen	Keluarga	Tidak
403	20	Laki-Laki	S1 Manajemen	Kos	Tidak
404	18	Laki-Laki	S1 Manajemen	Kos	Tidak
405	18	Perempuan	S1 Manajemen	Kos	Tidak
406	17	Perempuan	S1 Manajemen	Kos	Tidak
407	18	Perempuan	S1 Manajemen	Orang Tua	Tidak
408	19	Laki-Laki	S1 Manajemen	Keluarga	Tidak
409	18	Perempuan	S1 Manajemen	Orang Tua	Tidak
410	19	Perempuan	S1 Manajemen	Kontrak	Tidak
411	17	Perempuan	S1 Manajemen	Kos	Tidak
412	18	Laki-Laki	S1 Manajemen	Orang Tua	Tidak
413	18	Perempuan	S1 Manajemen	Kontrak	Tidak
414	18	Perempuan	S1 Manajemen	Orang Tua	Tidak
415	18	Perempuan	S1 Manajemen	Kos	Tidak
416	18	Perempuan	S1 Manajemen	Orang Tua	Tidak
417	19	Laki-Laki	S1 Manajemen	Kos	Tidak
418	18	Laki-Laki	S1 Manajemen	Kontrak	Tidak
419	18	Perempuan	S1 Manajemen	Orang Tua	Tidak

420	20	Perempuan	S1 Manajemen	Kos	Tidak
421	18	Laki-Laki	S1 Manajemen	Keluarga	Tidak
422	18	Laki-Laki	S1 Manajemen	Orang Tua	Tidak
423	18	Perempuan	S1 Manajemen	Orang Tua	Tidak
424	18	Perempuan	S1 Manajemen	Kos	Tidak
425	18	Perempuan	S1 Manajemen	Orang Tua	Tidak
426	19	Perempuan	S1 Manajemen	Orang Tua	Tidak
427	19	Perempuan	S1 Manajemen	Kontrak	Tidak
428	21	Laki-Laki	S1 Manajemen	Orang Tua	Tidak
429	19	Laki-Laki	S1 Manajemen	Orang Tua	Tidak
430	17	Perempuan	S1 Manajemen	Kos	Tidak
431	18	Laki-Laki	S1 Manajemen	Orang Tua	Tidak
432	19	Perempuan	S1 Manajemen	Kos	Tidak
433	19	Laki-Laki	S1 Manajemen	Kos	Tidak
434	18	Perempuan	S1 Manajemen	Kontrak	Tidak
435	18	Perempuan	S1 Manajemen	Orang Tua	Tidak
436	18	Perempuan	S1 Manajemen	Orang Tua	Tidak
437	18	Perempuan	S1 Manajemen	Orang Tua	Tidak
438	19	Perempuan	S1 Manajemen	Kos	Tidak
439	19	Perempuan	S1 Manajemen	Kos	Tidak
440	18	Laki-Laki	S1 Manajemen	Orang Tua	Tidak
441	18	Perempuan	S1 Manajemen	Orang Tua	Tidak
442	18	Perempuan	S1 Manajemen	Kos	Tidak
443	19	Perempuan	S1 Manajemen	Kos	Tidak
444	18	Perempuan	S1 Manajemen	Orang Tua	Tidak
445	18	Laki-Laki	S1 Manajemen	Orang Tua	Tidak

446	19	Perempuan	S1 Manajemen	Keluarga	Tidak
447	18	Perempuan	S1 Manajemen	Orang Tua	Tidak
448	18	Perempuan	S1 Manajemen	Kos	Tidak
449	18	Perempuan	S1 Manajemen	Kos	Tidak
450	18	Perempuan	S1 Manajemen	Orang Tua	Tidak
451	18	Perempuan	S1 Manajemen	Kos	Tidak
452	18	Perempuan	S1 Manajemen	Keluarga	Tidak
453	18	Laki-Laki	S1 Manajemen	Keluarga	Tidak
454	17	Perempuan	S1 Manajemen	Orang Tua	Tidak
455	18	Laki-Laki	S1 Manajemen	Orang Tua	Tidak
456	18	Perempuan	S1 Manajemen	Orang Tua	Tidak
457	18	Perempuan	S1 Manajemen	Kos	Tidak
458	18	Perempuan	S1 Manajemen	Kos	Tidak
459	19	Laki-Laki	S1 Manajemen	Orang Tua	Tidak
460	18	Perempuan	S1 Manajemen	Orang Tua	Tidak
461	18	Perempuan	S1 Manajemen	Keluarga	Tidak
462	18	Perempuan	S1 Manajemen	Orang Tua	Tidak
463	18	Perempuan	S1 Manajemen	Kos	Tidak
464	18	Perempuan	S1 Manajemen	Orang Tua	Tidak
465	18	Perempuan	S1 Manajemen	Orang Tua	Tidak
466	19	Perempuan	S1 Manajemen	Orang Tua	Tidak
467	19	Perempuan	S1 Manajemen	Kos	Tidak
468	18	Perempuan	S1 Manajemen	Keluarga	Tidak
469	19	Perempuan	S1 Manajemen	Keluarga	Tidak

470	19	Perempuan	S1 Manajemen	Keluarga	Tidak
471	42	Perempuan	alih jenjang	Keluarga	Ya
472	22	Perempuan	alih jenjang	Kos	Ya
473	36	Laki-Laki	alih jenjang	Orang Tua	Ya
474	42	Perempuan	alih jenjang	Keluarga	Ya
475	22	Perempuan	alih jenjang	Kos	Ya
476	27	Laki-Laki	alih jenjang	Kos	Ya
477	22	Perempuan	alih jenjang	Keluarga	Ya
478	44	Perempuan	alih jenjang	Keluarga	Ya
479	29	Laki-Laki	alih jenjang	Orang Tua	Ya
480	18	Perempuan	S1 Pendidikan Bahasa Inggris	Kos	Tidak
481	18	Laki-Laki	S1 Pendidikan Bahasa Inggris	Orang Tua	Tidak
482	18	Perempuan	S1 Pendidikan Bahasa Inggris	Orang Tua	Tidak
483	18	Perempuan	S1 Pendidikan Bahasa Inggris	Kos	Tidak
484	18	Perempuan	S1 Pendidikan Bahasa Inggris	Kos	Tidak
485	18	Perempuan	S1 Pendidikan Bahasa Inggris	Orang Tua	Tidak
486	18	Perempuan	S1 Pendidikan Bahasa Inggris	Kos	Tidak
487	18	Perempuan	S1 Pendidikan Bahasa Inggris	Kos	Tidak
488	18	Perempuan	S1 Pendidikan Bahasa Inggris	Kos	Tidak
489	19	Laki-Laki	S1 Pendidikan Bahasa Inggris	Keluarga	Tidak
490	18	Perempuan	S1 Pendidikan Bahasa Inggris	Kontrak	Tidak
491	18	Laki-Laki	S1 Pendidikan Bahasa Inggris	Orang Tua	Tidak
492	20	Laki-Laki	S1 Pendidikan Bahasa Inggris	Keluarga	Tidak
493	18	Perempuan	S1 Pendidikan Bahasa Inggris	Kos	Tidak

494	19	Laki-Laki	S1 Pendidikan Bahasa Inggris	Orang Tua	Tidak
495	18	Laki-Laki	S1 Pendidikan Bahasa Inggris	Orang Tua	Tidak
496	18	Perempuan	S1 Pendidikan Bahasa Inggris	Orang Tua	Tidak
497	19	Laki-Laki	S1 Pendidikan Olahraga	Orang Tua	Tidak
498	18	Laki-Laki	S1 Pendidikan Olahraga	Orang Tua	Tidak
499	20	Laki-Laki	S1 Pendidikan Olahraga	Kontrak	Tidak
500	18	Laki-Laki	S1 Pendidikan Olahraga	Keluarga	Tidak
501	18	Laki-Laki	S1 Pendidikan Olahraga	Kontrak	Tidak
502	17	Laki-Laki	S1 Pendidikan Olahraga	Orang Tua	Tidak
503	18	Perempuan	S1 Pendidikan Olahraga	Kos	Tidak
504	19	Laki-Laki	S1 Pendidikan Olahraga	Keluarga	Tidak
505	19	Laki-Laki	S1 Pendidikan Olahraga	Keluarga	Tidak
506	18	Laki-Laki	S1 Pendidikan Olahraga	Kos	Tidak
507	21	Laki-Laki	S1 Pendidikan Olahraga	Kos	Tidak
508	18	Laki-Laki	S1 Pendidikan Olahraga	Orang Tua	Tidak
509	20	Laki-Laki	S1 Pendidikan Olahraga	Kos	Tidak
510	18	Laki-Laki	S1 Pendidikan Olahraga	Kos	Tidak
511	25	Laki-Laki	S1 Pendidikan Olahraga	Kos	Tidak
512	20	Laki-Laki	S1 Pendidikan Olahraga	Kontrak	Tidak
513	19	Laki-Laki	S1 Pendidikan Olahraga	Kos	Tidak
514	18	Perempuan	S1 Psikolog	Kos	Tidak
515	19	Perempuan	S1 Psikolog	Orang Tua	Tidak
516	18	Perempuan	S1 Psikolog	Keluarga	Tidak

517	20	Laki-Laki	S1 Psikolog	Kontrak	Tidak
518	18	Laki-Laki	S1 Psikolog	Kos	Tidak
519	18	Perempuan	S1 Psikolog	Kontrak	Tidak
520	20	Perempuan	S1 Psikolog	Kos	Tidak
521	18	Laki-Laki	S1 Psikolog	Orang Tua	Tidak
522	18	Perempuan	S1 Psikolog	Kos	Tidak
523	21	Laki-Laki	S1 Psikolog	Keluarga	Tidak
524	19	Perempuan	S1 Psikolog	Kos	Tidak
525	19	Perempuan	S1 Psikolog	Orang Tua	Tidak
526	20	Perempuan	S1 Psikolog	Kos	Tidak
527	18	Perempuan	S1 Psikolog	Kos	Tidak
528	20	Perempuan	S1 Psikolog	Orang Tua	Tidak
529	19	Perempuan	S1 Psikolog	Kos	Tidak
530	20	Perempuan	S1 Psikolog	Kos	Tidak
531	18	Perempuan	S1 Psikolog	Kontrak	Tidak
532	18	Perempuan	S1 Psikolog	Orang Tua	Tidak
533	21	Laki-Laki	S1 Psikolog	Keluarga	Ya
534	18	Laki-Laki	S1 Psikolog	Keluarga	Tidak
535	18	Perempuan	S1 Psikolog	Keluarga	Tidak
536	21	Perempuan	S1 Psikolog	Keluarga	Tidak
537	18	Perempuan	S1 Psikolog	Orang Tua	Tidak
538	19	Laki-Laki	S1 Psikolog	Kos	Tidak
539	18	Perempuan	S1 Psikolog	Orang Tua	Tidak
540	17	Perempuan	S1 Psikolog	Kos	Tidak
541	19	Laki-Laki	S1 Psikolog	Orang Tua	Tidak
542	22	Perempuan	S1 Psikolog	Kos	Tidak

543	22	Perempuan	S1 Psikolog	Kontrak	Tidak
544	19	Laki-Laki	S1 Psikolog	Orang Tua	Tidak
545	18	Perempuan	S1 Psikolog	Orang Tua	Tidak
546	18	Perempuan	S1 Psikolog	Kos	Tidak
547	19	Perempuan	S1 Psikolog	Kos	Tidak
548	19	Laki-Laki	S1 Psikolog	Orang Tua	Tidak
549	22	Laki-Laki	S1 Psikolog	Orang Tua	Tidak
550	20	Laki-Laki	S1 Psikolog	Kos	Tidak
551	19	Perempuan	S1 Psikolog	Keluarga	Tidak
552	18	Perempuan	S1 Psikolog	Orang Tua	Tidak
553	18	Perempuan	S1 Psikolog	Orang Tua	Tidak
554	18	Laki-Laki	S1 Psikolog	Orang Tua	Tidak
555	18	Perempuan	S1 Psikolog	Orang Tua	Tidak
556	19	Perempuan	S1 Psikolog	Kos	Tidak
557	18	Perempuan	S1 Psikolog	Orang Tua	Tidak
558	19	Perempuan	S1 Psikolog	Orang Tua	Tidak
559	18	Perempuan	S1 Psikolog	Orang Tua	Tidak
560	18	Perempuan	S1 Psikolog	Kos	Tidak
561	19	Perempuan	S1 Psikolog	Kos	Tidak
562	19	Perempuan	S1 Psikolog	Orang Tua	Tidak
563	18	Laki-Laki	S1 Psikolog	Keluarga	Tidak
564	18	Perempuan	S1 Psikolog	Orang Tua	Tidak
565	19	Laki-Laki	S1 Psikolog	Orang Tua	Tidak
566	18	Perempuan	S1 Psikolog	Orang Tua	Tidak
567	22	Laki-Laki	S1 Psikolog	Kontrak	Tidak
568	18	Perempuan	S1 Psikolog	Orang Tua	Tidak

569	18	Perempuan	S1 Psikolog	Orang Tua	Tidak
570	19	Perempuan	S1 Psikolog	Kos	Tidak
571	18	Perempuan	S1 Psikolog	Orang Tua	Tidak
572	18	Perempuan	S1 Psikolog	Orang Tua	Tidak
573	18	Laki-Laki	S1 Psikolog	Orang Tua	Tidak
574	19	Perempuan	S1 Psikolog	Orang Tua	Tidak
575	18	Perempuan	S1 Psikolog	Orang Tua	Tidak
576	18	Laki-Laki	S1 Psikolog	Keluarga	Tidak
577	20	Perempuan	S1 Psikolog	Kos	Tidak
578	18	Perempuan	S1 Psikolog	Orang Tua	Tidak
579	19	Laki-Laki	S1 Psikolog	Orang Tua	Tidak
580	19	Perempuan	S1 Psikolog	Keluarga	Tidak
581	18	Perempuan	S1 Psikolog	Orang Tua	Tidak
582	18	Perempuan	S1 Psikolog	Kos	Tidak
583	22	Perempuan	S1 Psikolog	Kontrak	Tidak
584	20	Perempuan	S1 Psikolog	Orang Tua	Tidak
585	18	Perempuan	S1 Psikolog	Kos	Tidak
586	18	Perempuan	S1 Psikolog	Orang Tua	Tidak
587	18	Laki-Laki	S1 Psikolog	Keluarga	Tidak
588	19	Perempuan	S1 Teknik Geologi	Kontrak	Tidak
589	20	Laki-Laki	S1 Teknik Geologi	Orang Tua	Tidak
590	18	Laki-Laki	S1 Teknik Geologi	Orang Tua	Tidak
591	18	Perempuan	S1 Teknik Geologi	Kontrak	Tidak
592	18	Laki-Laki	S1 Teknik Geologi	Orang Tua	Tidak
593	19	Perempuan	S1 Teknik Geologi	Kos	Tidak
594	19	Laki-Laki	S1 Teknik Geologi	Orang Tua	Tidak
595	19	Laki-Laki	S1 Teknik Geologi	Kos	Tidak

596	18	Laki-Laki	S1 Teknik Geologi	Orang Tua	Tidak
597	18	Perempuan	S1 Teknik Geologi	Kontrak	Tidak
598	19	Laki-Laki	S1 Teknik Mesin	Orang Tua	Tidak
599	22	Laki-Laki	S1 Teknik Mesin	Keluarga	Tidak
600	18	Laki-Laki	S1 Teknik Mesin	Orang Tua	Tidak
601	18	Laki-Laki	S1 Teknik Mesin	Orang Tua	Tidak
602	19	Laki-Laki	S1 Teknik Mesin	Kos	Tidak
603	19	Laki-Laki	S1 Teknik Mesin	Keluarga	Tidak
604	18	Laki-Laki	S1 Teknik Mesin	Keluarga	Tidak
605	18	Laki-Laki	S1 Teknik Mesin	Orang Tua	Tidak
606	18	Laki-Laki	S1 Teknik Mesin	Orang Tua	Tidak
607	20	Laki-Laki	S1 Teknik Mesin	Orang Tua	Tidak
608	18	Laki-Laki	S1 Teknik Mesin	Kontrak	Tidak
609	18	Laki-Laki	S1 Teknik Mesin	Kos	Tidak
610	18	Laki-Laki	S1 Teknik Mesin	Orang Tua	Tidak
611	19	Laki-Laki	S1 Teknik Mesin	Kos	Tidak
612	18	Laki-Laki	S1 Teknik Mesin	Orang Tua	Tidak
613	18	Laki-Laki	S1 Teknik Mesin	Orang Tua	Tidak
614	17	Laki-Laki	S1 Teknik Mesin	Orang Tua	Tidak
615	18	Laki-Laki	S1 Teknik Mesin	Orang Tua	Tidak
616	20	Laki-Laki	S1 Teknik Mesin	Kos	Tidak
617	18	Laki-Laki	S1 Teknik Mesin	Keluarga	Tidak
618	18	Laki-Laki	S1 Teknik Mesin	Kos	Tidak
619	18	Laki-Laki	S1 Teknik Mesin	Kos	Tidak
620	18	Perempuan	S1 Teknik Mesin	Kos	Tidak
621	19	Laki-Laki	S1 Teknik Mesin	Kos	Tidak
622	18	Laki-Laki	S1 Teknik Mesin	Keluarga	Tidak
623	18	Laki-Laki	S1 Teknik Mesin	Kontrak	Tidak
624	19	Laki-Laki	S1 Teknik Mesin	Kos	Tidak
625	18	Laki-Laki	S1 Teknik Mesin	Orang Tua	Tidak
626	18	Laki-Laki	S1 Teknik Mesin	Orang Tua	Tidak
627	18	Laki-Laki	S1 Teknik Mesin	Kos	Tidak
628	18	Perempuan	S1 Teknik Sipil	Keluarga	Tidak
629	18	Laki-Laki	S1 Teknik Sipil	Keluarga	Tidak
630	18	Laki-Laki	S1 Teknik Sipil	Orang Tua	Ya
631	18	Laki-Laki	S1 Teknik Sipil	Keluarga	Tidak
632	18	Laki-Laki	S1 Teknik Sipil	Orang Tua	Tidak
633	20	Laki-Laki	S1 Teknik Sipil	Orang Tua	Tidak

634	17	Perempuan	S1 Teknik Sipil	Orang Tua	Tidak
635	18	Laki-Laki	S1 Teknik Sipil	Kos	Tidak
636	19	Laki-Laki	S1 Teknik Sipil	Orang Tua	Tidak
637	19	Laki-Laki	S1 Teknik Sipil	Kontrak	Ya
638	18	Perempuan	S1 Teknik Sipil	Kos	Tidak
639	18	Laki-Laki	S1 Teknik Sipil	Kos	Tidak
640	18	Laki-Laki	S1 Teknik Sipil	Kos	Tidak
641	18	Laki-Laki	S1 Teknik Sipil	Orang Tua	Tidak
642	22	Laki-Laki	S1 Teknik Sipil	Keluarga	Tidak
643	18	Laki-Laki	S1 Teknik Sipil	Orang Tua	Tidak
644	18	Perempuan	S1 Teknik Sipil	Orang Tua	Tidak
645	18	Perempuan	S1 Teknik Sipil	Kontrak	Tidak
646	18	Perempuan	S1 Teknik Sipil	Keluarga	Tidak
647	18	Perempuan	S1 Teknik Sipil	Orang Tua	Tidak
648	18	Laki-Laki	S1 Teknik Sipil	Orang Tua	Tidak
649	18	Laki-Laki	S1 Teknik Sipil	Kos	Tidak
650	19	Perempuan	S1 Teknik Sipil	Orang Tua	Tidak
651	19	Laki-Laki	S1 Teknik Sipil	Kos	Tidak
652	17	Perempuan	S1 Teknik Sipil	Orang Tua	Tidak
653	19	Perempuan	S1 Teknik Sipil	Kontrak	Tidak
654	19	Perempuan	S1 Teknik Sipil	Kos	Tidak
655	23	Perempuan	Profesi Ners	Kontrak	Tidak
656	22	Perempuan	Profesi Ners	Kos	Ya
657	22	Perempuan	Profesi Ners	Keluarga	Ya
658	20	Perempuan	Profesi Ners	Orang Tua	Ya
659	22	Perempuan	Profesi Ners	Kos	Ya
660	21	Laki-Laki	Profesi Ners	Kos	Ya
661	21	Perempuan	Profesi Ners	Kos	Ya
662	23	Laki-Laki	Profesi Ners	Kos	Ya

663	24	Perempuan	Profesi Ners	Kos	Ya
664	23	Perempuan	Profesi Ners	Kos	Ya
665	22	Perempuan	Profesi Ners	Kontrak	Ya
666	24	Laki-Laki	Profesi Ners	Keluarga	Ya
667	22	Laki-Laki	Profesi Ners	Kos	Ya
668	22	Perempuan	Profesi Ners	Kos	Ya
669	22	Laki-Laki	Profesi Ners	Kos	Ya
670	22	Perempuan	Profesi Ners	Kontrak	Ya
671	23	Laki-Laki	Profesi Ners	Kos	Ya
672	22	Perempuan	Profesi Ners	Kos	Ya
673	22	Laki-Laki	Profesi Ners	Kontrak	Ya
674	22	Laki-Laki	Profesi Ners	Kontrak	Ya
675	22	Laki-Laki	Profesi Ners	Kos	Ya
676	22	Laki-Laki	Profesi Ners	Orang Tua	Ya
677	22	Perempuan	Profesi Ners	Keluarga	Ya
678	24	Laki-Laki	Profesi Ners	Orang Tua	Ya
679	22	Perempuan	Profesi Ners	Kontrak	Ya
680	22	Perempuan	Profesi Ners	Orang Tua	Ya
681	23	Perempuan	Profesi Ners	Orang Tua	Ya
682	23	Perempuan	Profesi Ners	Kos	Ya
683	23	Perempuan	Profesi Ners	Orang Tua	Ya
684	21	Laki-Laki	Profesi Ners	Kos	Ya
685	22	Perempuan	Profesi Ners	Orang Tua	Ya
686	22	Perempuan	Profesi Ners	Kontrak	Ya
687	21	Perempuan	Profesi Ners	Kontrak	Ya
688	22	Perempuan	Profesi Ners	Orang Tua	Ya
689	22	Perempuan	Profesi Ners	Kontrak	Ya

690	22	Perempuan	Profesi Ners	Kontrak	Ya
691	35	Laki-Laki	S2 Manajemen	Keluarga	Ya
692	30	Laki-Laki	S2 Manajemen	Orang Tua	Ya
693	40	Laki-Laki	S2 Manajemen	Kontrak	Ya
694	25	Perempuan	S2 Manajemen	Keluarga	Ya
695	19	Laki-Laki	S1 Akutansi	Orang Tua	Tidak
696	18	Laki-Laki	S1 Akutansi	Orang Tua	Tidak
697	18	Laki-Laki	S1 Akutansi	Orang Tua	Tidak
698	19	Perempuan	S1 Akutansi	Kos	Tidak
699	19	Perempuan	S1 Akutansi	Orang Tua	Tidak
700	18	Laki-Laki	S1 Akutansi	Kontrak	Tidak
701	19	Laki-Laki	S1 Akutansi	Kos	Tidak
702	18	Laki-Laki	S1 Teknik Informatika	Keluarga	Tidak
703	19	Laki-Laki	S1 Teknik Informatika	Kos	Tidak
704	18	Perempuan	S1 Teknik Informatika	Orang Tua	Tidak
705	18	Laki-Laki	S1 Teknik Informatika	Orang Tua	Tidak
706	18	Perempuan	S1 Teknik Informatika	Kontrak	Tidak
707	18	Laki-Laki	S1 Teknik Informatika	Orang Tua	Tidak
708	20	Laki-Laki	S1 Teknik Informatika	Keluarga	Tidak
709	18	Laki-Laki	S1 Teknik Informatika	Kos	Tidak
710	18	Perempuan	S1 Teknik Informatika	Orang Tua	Tidak
711	18	Perempuan	S1 Teknik Informatika	Keluarga	Tidak
712	19	Laki-Laki	S1 Teknik Informatika	Orang Tua	Tidak
713	19	Perempuan	S1 Teknik Informatika	Orang Tua	Tidak
714	19	Laki-Laki	S1 Teknik Informatika	Orang Tua	Tidak
715	18	Laki-Laki	S1 Teknik Informatika	Keluarga	Tidak
716	18	Laki-Laki	S1 Teknik Informatika	Orang Tua	Tidak
717	20	Laki-Laki	S1 Teknik Informatika	Orang Tua	Tidak
718	19	Laki-Laki	S1 Teknik Informatika	Orang Tua	Tidak
719	18	Laki-Laki	S1 Teknik Informatika	Kontrak	Tidak
720	19	Laki-Laki	S1 Teknik Informatika	Kos	Ya
721	19	Perempuan	S1 Teknik Informatika	Keluarga	Tidak
722	18	Perempuan	S1 Teknik Informatika	Kontrak	Tidak

723	18	Laki-Laki	S1 Teknik Informatika	Kos	Tidak
724	19	Laki-Laki	S1 Teknik Informatika	Keluarga	Tidak
725	18	Laki-Laki	S1 Teknik Informatika	Kos	Tidak
726	19	Laki-Laki	S1 Teknik Informatika	Orang Tua	Tidak
727	18	Laki-Laki	S1 Teknik Informatika	Kos	Tidak
728	20	Perempuan	S1 Teknik Informatika	Keluarga	Tidak
729	20	Laki-Laki	S1 Teknik Informatika	Keluarga	Tidak
730	18	Laki-Laki	S1 Teknik Informatika	Kos	Tidak
731	19	Laki-Laki	S1 Teknik Informatika	Kos	Tidak
732	20	Laki-Laki	S1 Teknik Informatika	Orang Tua	Tidak
733	18	Laki-Laki	S1 Teknik Informatika	Orang Tua	Tidak
734	18	Laki-Laki	S1 Teknik Informatika	Keluarga	Tidak
735	19	Laki-Laki	S1 Teknik Informatika	Kos	Tidak
736	18	Laki-Laki	S1 Teknik Informatika	Kontrak	Tidak
737	18	Laki-Laki	S1 Teknik Informatika	Kos	Tidak
738	18	Laki-Laki	S1 Teknik Informatika	Keluarga	Tidak
739	19	Laki-Laki	S1 Teknik Informatika	Kontrak	Tidak
740	18	Laki-Laki	S1 Teknik Informatika	Orang Tua	Tidak
741	17	Laki-Laki	S1 Teknik Informatika	Orang Tua	Tidak
742	17	Laki-Laki	S1 Teknik Informatika	Keluarga	Tidak
743	21	Laki-Laki	S1 Teknik Informatika	Kos	Tidak
744	18	Perempuan	S1 Teknik Informatika	Kos	Tidak
745	18	Laki-Laki	S1 Teknik Informatika	Orang Tua	Tidak
746	18	Laki-Laki	S1 Teknik Informatika	Orang Tua	Tidak
747	18	Laki-Laki	S1 Teknik Informatika	Kos	Tidak
748	18	Laki-Laki	S1 Teknik Informatika	Kontrak	Tidak
749	18	Laki-Laki	S1 Teknik Informatika	Orang Tua	Tidak
750	18	Perempuan	S1 Teknik Informatika	Orang Tua	Tidak
751	19	Laki-Laki	S1 Teknik Informatika	Kos	Tidak
752	20	Laki-Laki	S1 Teknik Informatika	Orang Tua	Tidak
753	18	Laki-Laki	S1 Teknik Informatika	Orang Tua	Tidak
754	19	Laki-Laki	S1 Teknik Informatika	Orang Tua	Tidak
755	19	Laki-Laki	S1 Teknik Informatika	Kontrak	Tidak
756	19	Perempuan	S1 Teknik Informatika	Kos	Tidak
757	18	Laki-Laki	S1 Teknik Informatika	Kontrak	Tidak
758	19	Laki-Laki	S1 Teknik Informatika	Keluarga	Tidak
759	18	Laki-Laki	S1 Teknik Informatika	Keluarga	Tidak

760	18	Perempuan	S1 Teknik Informatika	Kos	Tidak
761	19	Laki-Laki	S1 Teknik Informatika	Orang Tua	Tidak
762	18	Laki-Laki	S1 Teknik Informatika	Keluarga	Tidak
763	20	Perempuan	S1 Teknik Informatika	Keluarga	Tidak
764	18	Perempuan	S1 Teknik Informatika	Kontrak	Tidak
765	19	Perempuan	S1 Teknik Informatika	Orang Tua	Tidak
766	19	Perempuan	S1 Teknik Informatika	Kontrak	Tidak
767	19	Laki-Laki	S1 Teknik Informatika	Kos	Tidak
768	18	Perempuan	S1 Teknik Informatika	Kos	Tidak
769	18	Laki-Laki	S1 Teknik Informatika	Keluarga	Tidak
770	19	Perempuan	S1 Teknik Informatika	Orang Tua	Tidak
771	21	Perempuan	S1 Teknik Informatika	Kontrak	Tidak
772	20	Perempuan	S1 Teknik Informatika	Orang Tua	Tidak
773	18	Laki-Laki	S1 Teknik Informatika	Kos	Tidak
774	18	Perempuan	S1 Teknik Informatika	Keluarga	Tidak
775	18	Laki-Laki	S1 Teknik Informatika	Orang Tua	Tidak

Data Kecemasan

No, Respo nden	X 1	X 2	X 3	X 4	X 5	X 6	X 7	X 8	X 9	X 10	X 11	X 12	X 13	X 14	X 15	X 16	X 17	X 18	X 19	X 20	An sie tas	
1	3	3	3	3	3	3	1	3	1	3	2	1	1	1	2	1	1	1	1	3	40	
2	3	3	4	2	4	1	3	4	3	4	3	2	3	2	4	3	3	3	3	3	3	60
3	3	3	2	3	4	1	3	4	1	3	4	1	1	2	4	4	1	1	4	4	53	
4	3	3	1	2	3	1	4	3	2	3	2	2	1	1	2	3	3	2	3	4	48	
5	3	4	3	1	4	2	3	3	3	3	3	3	2	2	2	2	2	2	2	3	52	
6	2	2	2	3	2	3	4	1	3	2	2	3	3	3	2	3	3	3	2	3	51	
7	2	2	3	3	2	3	3	1	2	3	2	4	1	2	1	2	2	2	3	4	47	
8	2	2	3	2	2	3	2	2	3	2	3	2	3	3	3	3	2	2	3	2	49	
9	2	3	1	1	3	1	1	1	1	2	1	3	3	1	1	1	2	2	3	3	36	
10	2	2	1	2	2	3	2	2	3	2	3	2	3	2	3	3	3	3	3	3	49	
11	3	3	1	1	3	2	3	4	2	1	2	1	1	1	2	2	1	1	2	2	38	
12	3	4	2	2	1	3	1	1	1	4	1	4	1	1	1	3	1	2	1	1	38	
13	3	2	1	1	1	2	1	2	1	3	1	1	1	1	1	2	3	1	3	1	32	
14	4	4	2	3	2	1	4	3	1	1	1	4	2	4	4	1	1	2	1	4	49	
15	3	3	3	4	3	3	4	2	2	3	1	1	4	1	1	4	1	2	2	1	48	
16	3	3	2	1	3	2	4	2	2	2	2	3	2	2	3	1	1	3	3	4	48	
17	3	3	2	3	3	1	4	3	3	2	2	2	2	3	4	2	3	4	4	1	54	
18	3	3	3	3	3	1	2	3	3	2	2	2	2	2	2	2	2	2	2	2	46	
19	4	4	1	1	4	2	2	1	1	4	4	2	2	4	1	3	2	2	2	4	50	
20	3	3	3	3	2	2	4	2	4	2	2	4	4	4	2	2	4	4	2	2	58	
21	3	3	3	2	2	1	4	2	1	3	3	2	2	2	2	2	1	3	3	3	47	
22	3	3	2	1	3	1	2	3	1	2	2	1	1	2	3	4	2	1	4	3	44	
23	1	1	4	3	2	3	4	2	1	1	2	2	4	1	2	4	2	1	1	2	43	
24	4	4	1	1	4	3	3	4	1	4	4	1	1	1	1	3	1	4	1	1	47	
25	3	3	1	1	2	1	2	3	1	4	3	1	1	1	3	2	1	1	2	4	40	
26	4	3	3	3	3	3	1	2	3	2	2	2	3	2	2	2	2	1	2	2	47	
27	2	1	2	4	1	3	4	1	4	1	1	2	4	3	1	2	3	3	1	2	45	
28	4	3	1	1	4	2	1	4	1	4	1	4	1	1	1	1	4	2	4	3	47	
29	3	3	2	2	2	1	2	3	3	2	2	2	2	2	2	2	2	2	2	1	42	
30	3	3	1	2	3	2	2	3	3	3	3	2	2	2	3	3	2	3	2	2	49	
31	2	2	1	2	2	1	4	2	2	2	1	1	1	2	2	1	2	2	2	2	36	
32	2	3	3	1	2	1	2	2	2	3	3	2	2	2	2	3	2	2	2	2	43	
33	3	3	1	3	4	3	4	2	1	1	2	1	3	2	4	1	1	1	1	1	42	
34	2	2	1	2	2	2	2	2	2	2	2	4	2	2	2	2	2	2	2	2	41	
35	2	2	3	3	2	3	3	3	3	3	1	2	2	2	2	1	3	3	1	2	46	
36	2	4	2	1	3	4	1	4	4	2	1	1	4	3	3	4	4	3	3	3	56	

37	3	3	1	1	4	1	2	3	1	4	4	1	1	1	4	3	2	1	4	4	48
38	3	3	2	2	4	3	2	4	1	4	4	3	1	2	1	1	2	2	1	4	49
39	3	3	1	1	2	1	3	3	3	3	3	2	2	2	3	2	4	2	2	3	48
40	3	3	2	2	3	2	2	2	2	3	3	2	2	2	4	3	2	2	1	3	48
41	3	3	2	2	3	3	2	2	3	3	2	3	3	2	2	3	3	2	3	3	52
42	3	3	2	2	2	2	3	3	2	3	3	3	2	2	3	3	2	2	3	3	51
43	2	2	3	2	3	3	3	2	2	3	3	3	3	3	2	3	3	3	2	2	52
44	2	3	1	1	2	4	4	2	4	2	3	3	4	4	3	2	4	4	2	2	56
45	4	4	1	1	3	1	2	1	1	4	2	1	1	1	2	2	1	1	2	4	39
46	2	3	2	3	2	2	2	2	2	4	2	2	2	2	2	2	2	3	2	3	46
47	3	3	2	3	3	2	2	3	2	3	2	2	3	2	3	2	3	3	2	3	51
48	3	3	2	2	3	2	2	2	2	3	2	2	2	2	2	2	2	2	2	2	44
49	3	3	2	1	3	1	2	3	1	4	3	1	1	1	2	2	3	3	2	4	45
50	3	3	2	1	3	1	2	3	2	3	4	2	2	1	3	3	2	1	3	3	47
51	3	2	2	2	3	3	4	2	4	3	4	4	4	3	2	3	3	2	2	2	57
52	2	4	2	3	3	1	3	2	3	3	2	2	2	2	3	2	2	1	2	4	48
53	3	4	2	2	4	1	2	3	2	4	3	2	2	2	2	4	3	3	3	4	55
54	1	2	3	3	1	4	3	1	4	1	2	3	4	3	1	2	4	4	1	1	48
55	3	3	2	2	3	2	2	4	2	2	2	2	2	2	2	2	2	2	3	3	47
56	3	4	2	1	2	2	3	3	2	3	3	2	2	1	3	2	2	2	3	3	48
57	3	4	3	4	3	4	2	4	2	4	3	4	2	3	3	2	2	1	4	4	61
58	3	4	1	3	3	3	3	2	3	2	2	3	3	3	2	2	3	3	2	3	53
59	3	3	2	3	3	4	4	2	4	4	4	3	4	3	3	3	3	3	2	4	64
60	3	4	2	1	3	3	1	3	2	1	2	1	3	3	1	1	1	3	2	1	41
61	3	3	3	1	3	1	2	4	1	4	4	1	1	2	4	3	1	1	3	4	49
62	3	3	2	2	3	1	3	3	2	4	3	2	2	2	3	3	2	1	3	3	50
63	3	3	2	2	3	1	3	3	2	4	3	3	3	3	4	3	3	3	3	3	57
64	3	3	2	1	2	3	2	3	4	3	4	4	3	2	1	2	3	2	2	3	52
65	3	3	3	2	2	2	2	3	2	3	3	2	3	2	3	2	2	3	3	3	51
66	3	3	2	2	3	2	2	3	2	3	3	2	2	2	3	3	2	2	3	3	50
67	4	3	1	1	4	3	3	4	1	4	3	1	1	1	4	3	1	1	3	4	50
68	1	3	2	1	1	3	4	2	2	1	2	2	2	1	1	1	4	4	4	1	42
69	1	4	1	3	3	1	3	3	3	2	4	4	3	2	2	2	2	2	2	3	50
70	3	3	1	1	3	1	2	3	1	3	2	2	1	1	4	3	1	1	3	4	43
71	1	2	3	4	2	2	4	2	4	3	1	4	4	4	1	1	4	4	2	2	54
72	4	3	3	1	2	3	3	4	4	4	4	3	3	1	4	4	1	1	4	2	58
73	2	3	4	3	2	4	4	3	4	2	3	3	4	3	2	2	4	3	2	1	58
74	3	3	2	2	3	1	2	2	2	3	3	3	3	2	2	2	2	2	3	3	48
75	3	3	2	3	3	2	2	2	3	3	3	2	2	2	3	3	3	2	2	3	51
76	3	3	2	1	2	2	2	2	2	3	3	1	1	1	3	3	1	2	3	4	44
77	3	3	2	1	3	1	2	2	2	3	3	2	1	4	2	2	3	2	3	4	48

78	3	3	2	1	3	1	3	3	1	3	4	1	2	3	3	3	1	2	4	4	50
79	4	4	1	1	4	1	2	4	1	4	4	2	1	1	3	2	1	1	3	4	48
80	2	2	2	3	2	2	3	2	1	2	2	2	2	2	3	1	2	2	2	2	41
81	2	2	2	2	3	2	3	2	2	2	2	2	2	2	3	2	2	2	2	2	43
82	3	3	3	2	3	1	2	2	2	2	3	2	3	3	2	2	2	2	2	2	46
83	2	1	1	1	1	1	3	1	1	1	1	1	1	1	3	1	1	1	1	2	26
84	2	3	2	2	2	2	2	2	1	2	3	2	2	1	2	3	2	1	2	3	41
85	3	3	3	2	2	1	2	1	2	1	1	2	2	3	2	1	3	2	3	4	43
86	3	3	1	1	3	2	4	1	3	3	3	1	1	3	3	3	1	4	1	2	46
87	3	2	2	2	3	1	4	3	2	3	3	2	2	2	3	2	2	3	2	3	49
88	4	4	3	3	3	1	2	3	2	3	2	1	1	1	2	2	1	1	2	3	44
89	3	3	2	3	3	3	4	4	3	4	3	1	3	1	1	3	3	3	3	2	55
90	2	3	3	3	3	2	4	2	4	2	2	2	4	3	2	1	4	4	1	1	52
91	3	3	3	2	2	4	1	2	3	3	2	3	2	3	2	1	1	4	1	3	48
92	4	4	1	4	1	1	1	1	1	4	4	4	4	4	2	2	4	1	4	4	55
93	2	3	3	1	3	3	3	4	3	3	4	3	2	3	3	2	3	3	4	4	59
94	2	2	3	2	2	2	2	2	2	2	2	2	2	2	2	2	2	2	2	2	41
95	2	3	2	2	3	2	2	2	3	1	3	2	2	3	3	3	2	2	3	3	48
96	2	2	2	2	2	2	2	4	1	2	2	2	1	1	2	2	2	4	4	1	42
97	4	4	1	1	4	1	1	4	1	4	4	1	1	1	4	4	2	2	4	4	52
98	3	3	3	4	2	3	3	3	2	4	4	2	2	1	3	3	2	3	3	4	57
99	2	2	2	2	3	2	4	2	3	2	2	3	2	2	2	4	4	4	4	4	55
100	2	2	3	2	3	1	1	2	2	2	2	2	2	2	2	1	1	2	1	2	37
101	3	3	2	3	3	1	1	2	1	4	2	2	1	1	3	4	4	1	1	1	43
102	2	2	1	1	1	1	4	4	1	3	3	1	1	1	1	1	2	2	1	2	35
103	4	4	1	1	4	1	1	4	1	4	4	1	1	1	4	4	1	1	4	4	50
104	3	2	3	1	3	4	3	4	1	3	3	3	2	2	4	3	3	2	3	4	56
105	2	1	1	2	2	3	4	2	3	2	3	2	2	3	3	2	2	3	3	3	48
106	2	4	4	1	3	2	4	3	2	4	3	2	2	3	4	2	2	4	2	3	56
107	3	4	3	1	2	2	4	2	2	3	2	2	3	3	3	3	2	1	3	3	51
108	4	4	2	2	3	2	1	4	2	4	4	2	2	2	4	4	1	2	4	4	57
109	2	3	1	1	3	1	2	2	1	2	2	1	1	1	3	2	1	3	2	2	36
110	3	3	3	1	3	2	3	3	3	3	3	3	3	3	3	3	3	3	3	3	57
111	1	2	1	1	3	4	4	1	1	1	1	1	1	1	4	1	1	1	1	1	32
112	1	2	1	1	1	1	1	1	1	1	1	2	1	2	1	2	3	1	1	1	26
113	3	2	2	1	4	2	4	3	3	4	4	3	3	3	3	3	3	3	4	4	61
114	1	2	2	2	1	2	4	1	4	1	2	4	4	4	1	1	4	4	1	2	47
115	3	3	3	2	3	1	3	3	1	3	3	3	2	3	2	2	3	3	3	3	52
116	3	3	3	3	3	2	2	3	3	3	3	3	3	2	3	2	3	3	3	3	56
117	2	2	3	3	3	2	3	4	3	3	2	3	3	3	3	3	2	2	3	3	55
118	3	3	3	2	3	2	3	3	3	3	3	2	2	2	2	3	3	2	3	3	53

119	4	4	3	1	3	1	2	4	2	4	3	3	1	1	3	3	2	1	4	4	53
120	3	3	4	1	3	1	4	4	4	2	3	3	3	3	3	1	4	4	2	2	57
121	2	4	4	1	4	1	2	4	3	4	4	2	1	3	2	2	3	3	2	3	54
122	2	3	1	2	3	1	3	2	3	3	2	2	2	2	3	2	2	2	2	3	45
123	4	4	3	1	3	2	2	4	2	4	4	3	3	3	4	4	4	3	4	3	64
124	2	2	3	2	2	1	4	2	2	2	1	4	3	3	2	2	2	4	2	2	47
125	4	4	2	2	4	1	1	4	2	4	3	1	1	2	3	3	2	2	3	4	52
126	3	2	2	4	2	2	4	2	3	3	3	3	1	1	2	2	1	1	3	3	47
127	4	4	1	1	4	2	1	4	1	4	4	1	1	1	4	4	2	1	4	4	52
128	3	3	2	1	3	1	2	2	2	3	2	1	1	1	3	3	2	2	4	4	45
129	3	2	2	3	2	3	4	2	3	2	2	3	3	3	3	3	3	3	3	3	55
130	4	4	1	1	4	1	3	4	1	4	3	1	1	3	4	3	3	2	3	4	54
131	3	4	2	3	2	2	3	2	1	4	4	2	2	3	2	2	1	4	2	4	52
132	3	3	3	3	3	2	2	3	3	3	4	4	3	3	2	2	4	4	2	3	59
133	2	3	3	3	2	3	4	2	4	2	2	2	3	3	2	2	3	3	2	2	52
134	4	4	3	3	4	3	2	2	4	3	2	2	2	2	3	3	3	3	3	4	59
135	4	4	3	3	4	3	2	2	4	3	2	2	2	2	3	3	3	3	3	4	59
136	3	3	1	2	2	1	1	1	1	3	3	4	1	3	2	1	1	3	1	3	40
137	2	3	2	2	2	1	2	2	2	1	2	2	1	2	2	2	2	2	2	1	37
138	2	3	2	3	2	3	3	2	2	3	3	2	3	4	2	1	3	3	4	3	53
139	2	3	2	2	2	2	3	3	3	2	2	2	2	2	2	2	2	3	2	3	46
140	2	4	4	1	4	1	4	4	2	4	1	4	4	4	3	2	1	2	1	3	55
141	4	3	1	2	3	1	3	3	2	3	3	2	1	2	1	2	3	1	3	4	47
142	1	2	3	4	2	3	3	3	2	1	2	4	3	3	1	2	4	4	2	2	51
143	3	4	1	2	4	1	1	4	1	4	4	1	2	2	4	4	1	2	4	4	53
144	3	3	3	3	3	3	3	3	3	3	3	3	3	3	3	3	3	3	3	3	60
145	2	4	1	2	1	2	3	1	2	2	1	2	3	2	2	2	2	3	2	2	41
146	2	2	1	3	2	2	3	3	2	2	3	2	1	2	3	2	3	3	2	3	46
147	3	3	3	3	3	3	3	3	4	3	1	3	3	3	2	1	4	4	2	3	57
148	3	3	2	4	3	2	3	2	3	3	3	3	3	3	4	3	4	3	3	3	60
149	4	4	4	4	4	1	4	4	1	4	4	2	1	1	4	4	4	4	4	4	66
150	1	2	1	4	2	3	4	2	4	2	1	4	4	4	1	1	4	4	1	1	50
151	3	3	2	2	3	3	3	2	3	3	2	3	3	3	2	2	3	3	2	2	52
152	2	3	4	4	3	3	3	4	2	2	2	2	1	4	3	2	4	3	3	4	58
153	4	3	1	4	3	3	3	4	3	4	2	1	1	3	3	3	3	1	2	4	55
154	3	3	2	3	2	1	4	2	3	2	2	2	3	1	2	3	3	2	2	3	48
155	4	4	4	1	4	1	1	4	1	4	3	3	1	1	2	1	1	1	2	3	46
156	2	3	1	2	2	3	4	4	4	2	2	2	3	3	1	1	2	3	2	2	48
157	2	3	3	4	2	3	4	2	3	2	2	3	3	2	2	2	3	2	3	2	52
158	3	3	4	2	3	4	4	3	4	3	2	3	3	3	3	3	3	3	2	3	61
159	4	4	2	1	2	1	2	4	2	2	3	3	2	3	3	3	3	3	3	3	53

160	3	1	2	1	1	3	2	3	3	3	2	2	3	3	4	3	3	3	2	3	50
161	2	2	2	2	2	2	2	2	2	2	2	2	2	2	2	2	2	2	2	2	40
162	2	2	3	1	2	2	2	2	2	2	2	2	2	2	2	2	2	2	2	2	40
163	4	4	1	1	1	2	2	4	1	4	4	4	4	3	4	2	4	2	4	2	57
164	2	4	1	1	4	3	1	4	2	4	1	4	3	1	4	3	3	1	3	4	53
165	2	4	1	2	4	3	2	2	2	2	2	2	2	2	2	2	2	2	2	2	44
166	3	2	2	2	2	1	4	1	4	2	2	4	1	1	2	1	4	3	1	2	44
167	2	2	2	2	2	1	3	2	2	2	3	2	2	2	3	2	2	2	3	2	43
168	3	3	2	1	3	2	2	3	2	3	3	1	2	2	3	3	2	2	3	3	48
169	1	3	1	1	3	4	4	1	1	2	3	1	1	1	3	1	2	1	2	1	37
170	4	4	1	1	4	1	1	4	1	4	4	1	1	1	4	3	1	3	4	4	51
171	2	3	1	2	3	1	2	4	1	4	4	4	3	3	2	4	3	3	1	3	53
172	3	4	1	1	4	2	1	4	1	4	4	3	3	3	3	3	3	3	4	4	58
173	1	2	3	3	2	2	2	2	2	2	2	2	2	2	2	2	2	2	2	2	41
174	2	3	2	2	3	2	4	2	3	2	3	2	4	2	2	1	4	2	2	1	48
175	4	4	1	1	4	1	1	4	1	4	4	3	1	1	4	3	3	3	3	4	54
176	4	4	3	4	1	3	4	1	4	1	1	4	4	4	1	1	4	4	1	1	54
177	2	3	1	2	2	2	4	2	2	2	2	2	2	2	2	2	2	2	2	2	42
178	4	4	2	1	4	1	3	4	2	4	3	2	1	3	4	4	1	1	4	4	56
179	2	3	1	3	2	1	2	1	3	2	3	3	2	2	2	2	2	2	3	1	42
180	2	3	3	4	1	2	3	4	3	3	3	3	3	3	2	2	3	3	1	3	54
181	3	3	1	1	2	1	1	1	1	3	3	1	1	3	1	1	1	1	2	2	33
182	3	3	3	3	3	2	4	3	4	2	2	2	4	3	2	2	4	3	2	2	56
183	3	3	1	1	2	3	2	4	2	4	2	3	1	1	4	3	1	1	3	3	47
184	2	2	1	2	2	1	2	2	1	3	2	2	3	2	2	2	2	3	2	2	40
185	2	2	4	2	2	2	2	2	2	2	2	2	2	2	2	2	2	2	2	2	42
186	3	1	4	4	1	1	4	1	4	3	1	4	4	4	1	3	4	4	3	3	57
187	2	3	1	2	3	4	3	2	2	4	3	1	1	4	3	4	4	3	3	4	56
188	1	1	3	3	1	4	4	2	4	1	1	4	4	4	2	2	4	4	1	3	53
189	3	4	2	1	2	1	3	1	3	4	4	1	1	4	4	2	3	1	4	4	52
190	4	4	4	1	4	1	2	4	1	4	1	1	3	1	4	2	3	3	4	4	55
191	4	4	1	1	1	4	4	4	4	4	4	4	4	4	4	4	4	4	3	4	70
192	4	4	2	1	4	3	1	4	1	3	4	1	1	1	4	3	2	2	4	4	53
193	2	3	1	2	3	3	4	3	3	4	3	3	3	3	3	3	3	3	3	3	58
194	4	4	1	1	1	2	1	4	1	4	4	1	1	1	3	2	1	1	2	4	43
195	2	2	1	1	3	3	4	1	4	2	3	1	2	3	4	2	4	4	2	4	52
196	2	2	2	2	2	2	2	2	2	2	2	2	2	2	2	2	2	2	2	2	40
197	2	4	3	2	3	2	3	2	1	3	2	2	3	3	3	2	3	2	4	3	52
198	3	3	1	1	3	2	4	4	2	3	4	2	2	3	4	3	2	2	2	3	53
199	3	3	1	1	3	1	2	4	1	4	3	2	1	1	3	3	1	1	3	3	44
200	3	4	1	2	3	2	3	3	1	4	3	2	1	2	4	2	1	2	2	3	48

201	2	2	3	2	2	2	2	2	2	1	2	2	2	2	2	2	2	2	2	40
202	2	3	1	1	1	1	2	1	1	2	2	2	2	1	1	1	1	1	1	28
203	2	3	3	2	1	1	3	1	1	2	2	2	1	2	2	1	2	2	1	36
204	3	3	3	2	3	1	3	3	2	3	2	2	2	3	3	2	3	3	1	49
205	3	3	3	3	2	3	3	2	3	2	2	3	3	3	2	2	3	3	2	52
206	3	3	2	2	3	2	3	4	3	3	3	3	3	3	4	3	3	3	3	59
207	3	3	2	3	3	3	2	3	2	3	4	2	2	1	3	3	3	2	2	51
208	2	2	3	3	2	1	4	3	3	2	2	3	4	4	3	2	4	4	3	57
209	3	2	1	1	2	2	1	4	2	4	3	1	1	1	3	2	1	1	2	41
210	2	3	3	3	3	3	3	4	3	3	3	3	3	3	3	3	3	3	3	60
211	3	3	1	1	3	1	1	3	1	3	4	3	1	2	4	3	1	1	3	45
212	3	2	3	3	4	2	4	1	4	2	4	1	4	4	1	1	4	3	2	53
213	3	3	1	1	3	1	1	3	1	3	3	2	1	1	4	4	2	2	2	44
214	3	2	4	2	1	2	1	1	2	2	2	3	2	3	4	2	2	3	3	47
215	3	3	3	4	1	4	4	1	4	2	2	3	4	3	2	1	4	3	1	54
216	3	3	1	2	2	2	1	1	2	2	4	1	2	2	3	2	2	2	3	42
217	2	4	2	3	2	1	4	2	2	2	3	3	4	4	3	1	3	3	3	53
218	4	4	1	1	4	1	1	4	1	4	4	1	1	1	4	4	1	1	4	50
219	3	3	2	2	3	3	3	4	2	4	3	3	2	3	4	3	3	3	2	59
220	2	3	1	3	3	3	3	3	3	3	3	2	3	3	3	3	3	3	3	56
221	2	2	1	1	2	1	1	2	1	2	2	1	1	1	2	1	1	1	2	30
222	2	3	4	3	1	1	1	3	3	1	4	2	2	2	4	2	2	4	1	48
223	3	3	2	4	3	2	2	2	3	3	3	2	3	3	3	3	4	3	3	57
224	3	3	2	2	3	1	2	3	2	3	3	2	2	2	3	3	2	2	4	51
225	2	4	3	2	2	1	4	2	3	2	2	2	2	4	3	2	3	4	2	52
226	3	3	2	2	2	1	4	3	3	3	3	3	2	3	4	3	2	3	3	56
227	2	1	1	1	2	1	2	2	1	2	2	2	1	3	4	1	1	1	4	36
228	4	4	3	1	3	1	1	4	1	4	4	3	1	1	3	4	1	2	4	53
229	4	3	1	1	2	1	2	4	2	3	3	1	1	1	2	2	1	1	2	39
230	2	2	4	4	1	4	4	2	4	2	1	4	4	4	2	1	4	3	2	56
231	2	4	1	1	2	2	2	2	1	2	2	1	1	1	2	2	2	2	2	36
232	3	4	2	1	3	1	2	2	2	3	2	3	2	2	4	4	2	2	2	50
233	2	4	2	1	4	1	4	2	1	4	3	3	1	1	4	2	1	1	2	47
234	3	4	1	1	3	1	2	3	2	3	2	2	1	1	2	2	3	2	4	46
235	3	4	1	1	3	1	2	4	1	4	3	3	1	1	4	1	1	1	4	46
236	2	3	4	3	3	2	3	4	4	3	3	4	3	4	3	4	3	3	3	64
237	4	3	1	1	3	1	2	2	2	3	4	1	1	1	2	2	2	1	3	42
238	2	3	2	3	3	1	4	2	2	2	3	3	3	2	3	3	2	2	2	49
239	2	3	1	3	2	4	2	4	3	4	3	2	3	3	3	3	2	4	3	57
240	1	3	4	2	1	1	4	1	3	2	1	3	3	4	1	2	3	4	3	47
241	4	3	1	1	4	2	3	4	1	4	3	2	2	2	3	2	2	2	3	51

242	1	2	1	1	2	3	3	1	1	2	1	1	3	4	2	1	3	3	1	1	37
243	2	3	3	3	2	4	3	2	3	2	2	3	3	3	2	2	3	3	2	2	52
244	3	4	2	1	4	1	2	4	2	3	3	2	2	2	3	2	3	3	3	4	53
245	3	4	1	1	3	2	1	4	2	3	3	1	1	2	3	3	1	1	2	1	42
246	2	3	1	1	3	1	2	2	2	3	2	2	1	2	3	1	1	2	3	3	40
247	3	4	1	2	3	1	3	3	2	3	3	3	3	4	3	3	2	4	3	3	56
248	2	3	2	2	3	2	3	4	2	3	2	3	3	3	3	3	2	3	2	3	53
249	3	3	2	1	3	2	2	3	2	3	3	2	2	2	3	2	2	3	3	3	49
250	3	3	2	2	3	2	2	4	3	3	3	2	2	2	3	3	3	3	3	3	54
251	3	3	3	2	2	2	3	2	3	3	2	3	3	4	2	2	3	3	2	2	52
252	3	2	1	1	3	3	3	3	3	3	3	1	2	2	3	3	2	1	2	3	47
253	3	3	3	1	4	4	3	4	2	4	4	3	3	3	1	1	4	3	3	4	60
254	4	2	3	2	3	2	4	3	4	3	3	3	4	4	3	1	4	4	3	3	62
255	3	2	2	2	3	2	2	3	3	3	3	2	3	3	3	2	2	2	3	3	51
256	3	2	2	3	3	3	4	3	3	2	4	4	3	3	3	4	4	4	2	3	62
257	3	3	3	3	3	3	3	3	3	3	2	3	3	3	2	2	3	2	2	2	54
258	4	4	2	2	3	1	3	4	3	4	3	2	1	2	2	2	2	2	2	4	52
259	3	3	2	2	3	2	2	3	2	3	3	3	2	3	4	4	2	3	3	4	56
260	3	2	3	3	2	2	3	2	3	3	3	3	3	2	3	1	2	1	3	3	50
261	2	2	4	2	2	3	4	2	4	3	1	4	4	4	2	2	4	4	2	3	58
262	4	1	1	1	4	1	1	4	1	4	3	1	1	1	3	3	1	1	4	4	44
263	2	2	2	3	2	3	3	2	2	2	2	3	3	2	2	2	2	2	2	2	45
264	2	3	3	3	1	1	1	4	3	3	2	2	3	4	2	3	2	3	2	3	50
265	3	3	1	3	2	1	4	4	2	3	2	2	2	2	3	3	4	2	3	4	53
266	2	4	1	1	3	4	4	1	2	4	4	2	4	4	1	1	4	1	2	4	53
267	3	3	1	2	2	4	4	4	4	2	2	2	2	2	1	2	4	4	3	3	54
268	2	3	1	1	1	1	1	2	1	3	3	1	1	1	3	3	1	1	1	3	34
269	2	4	3	2	2	3	4	1	2	2	1	2	2	2	2	2	3	2	1	2	44
270	1	3	2	1	1	1	1	3	1	1	1	1	1	1	1	1	1	1	1	3	27
271	4	4	4	1	4	1	1	4	1	4	4	2	2	3	3	4	1	1	1	3	52
272	2	3	1	1	2	1	1	3	1	3	3	2	2	2	2	2	2	2	2	2	39
273	2	4	2	1	3	1	3	4	1	3	2	1	1	1	3	3	2	2	3	4	46
274	4	4	4	1	4	1	3	4	4	4	2	3	1	3	4	2	1	3	4	4	60
275	4	4	1	1	3	2	4	3	2	3	1	1	1	3	3	2	2	2	1	3	46
276	2	3	1	1	3	2	2	3	1	3	4	1	1	1	4	2	2	1	2	3	42
277	3	3	2	3	2	4	4	3	3	2	3	1	4	4	3	2	4	4	2	3	59
278	3	3	1	3	3	4	4	3	2	3	3	1	1	3	3	3	3	2	3	3	54
279	3	4	1	1	4	2	1	4	1	4	2	1	2	1	3	4	3	1	4	4	50
280	2	4	2	2	3	1	2	4	1	4	3	2	1	1	4	3	1	1	2	4	47
281	2	2	1	4	2	1	4	1	3	2	3	1	1	2	2	2	3	3	3	2	44
282	3	3	3	2	3	1	2	3	3	2	2	2	2	2	3	2	2	2	2	3	47

283	2	2	2	2	3	2	3	2	3	3	3	2	2	3	3	2	2	2	3	3	49
284	2	2	1	1	3	2	1	2	1	3	3	2	1	3	2	2	2	3	1	3	40
285	3	3	2	2	3	2	4	4	2	2	2	2	2	2	2	2	2	2	2	2	47
286	3	4	2	1	4	1	2	4	1	4	2	2	1	1	4	4	1	1	4	4	50
287	3	2	3	3	2	3	3	3	4	3	3	3	3	3	2	2	4	3	2	3	57
288	1	1	1	1	1	1	1	1	1	1	1	2	1	2	4	4	3	2	4	4	37
289	3	4	2	2	3	2	3	4	3	4	3	3	1	3	4	3	2	3	3	4	59
290	3	3	1	2	3	2	2	3	2	3	3	2	2	2	2	2	3	4	3	3	50
291	3	4	1	2	4	3	3	3	2	3	4	1	1	3	4	4	2	3	3	3	56
292	3	4	1	2	4	2	1	4	1	4	3	1	1	1	4	4	1	1	4	4	50
293	2	3	1	2	3	1	2	4	2	4	3	2	2	3	2	2	3	2	3	4	50
294	2	2	3	3	2	3	3	3	3	2	1	3	3	2	2	2	3	3	2	3	50
295	2	3	2	3	2	4	4	4	4	2	1	3	4	4	2	1	3	3	2	2	55
296	2	2	1	2	2	1	3	1	2	2	2	1	2	2	3	2	1	2	2	3	38
297	3	3	2	3	3	1	2	2	2	3	2	2	2	2	2	1	2	2	1	2	42
298	3	2	1	4	2	4	4	2	4	2	2	3	3	3	2	2	4	3	2	3	55
299	4	4	1	1	4	1	2	3	1	1	4	1	1	1	4	2	1	1	3	4	44
300	4	4	1	1	4	1	2	4	1	2	3	1	1	1	4	2	2	2	4	4	48
301	3	3	2	4	4	2	2	3	1	3	4	2	2	2	4	3	2	2	3	4	55
302	2	3	2	2	1	4	4	2	3	1	1	2	4	3	2	1	4	4	1	2	48
303	2	2	1	2	2	1	1	3	1	2	2	1	1	2	3	2	1	2	2	3	36
304	4	4	1	1	4	1	1	4	1	4	4	1	1	1	4	4	1	1	4	4	50
305	2	4	2	3	2	2	4	2	4	2	2	3	4	4	2	2	4	4	3	3	58
306	3	3	1	4	3	1	2	2	3	3	3	1	2	2	3	3	3	3	3	3	51
307	3	3	3	3	3	2	4	3	3	3	2	2	3	2	3	3	3	3	3	3	57
308	2	3	1	1	3	1	4	3	2	3	3	2	3	4	2	2	4	4	2	2	51
309	2	3	1	3	3	1	3	1	3	3	2	1	3	3	3	2	3	3	2	4	49
310	3	3	1	1	3	2	3	2	2	3	3	4	2	2	3	2	2	2	2	3	48
311	2	4	1	1	4	1	1	3	4	4	3	3	2	2	3	2	1	4	3	3	51
312	3	3	3	2	3	2	2	3	2	3	3	2	3	3	3	3	3	3	4	3	56
313	3	4	1	2	3	2	2	4	3	4	4	2	1	2	4	4	2	2	4	4	57
314	3	3	3	2	2	2	2	4	1	2	3	3	3	3	3	3	2	1	4	3	52
315	3	3	3	2	2	2	3	3	3	2	3	3	2	3	2	2	4	3	2	3	53
316	3	4	3	3	2	1	4	3	2	3	4	2	2	1	3	2	2	2	2	3	51
317	1	3	4	4	1	1	2	2	1	1	3	1	2	2	1	4	2	1	1	1	38
318	4	4	4	1	4	1	1	4	1	3	4	1	1	1	3	3	1	1	3	4	49
319	2	2	2	2	2	1	1	3	2	3	3	1	2	2	3	2	3	3	2	3	44
320	3	3	2	3	2	3	2	3	3	4	3	3	3	1	3	1	4	1	2	3	52
321	3	3	1	1	3	1	2	4	1	3	3	1	1	1	3	3	1	1	3	4	43
322	3	3	3	2	3	3	3	3	1	4	3	3	2	1	4	3	2	2	3	4	55
323	3	1	2	3	4	2	4	4	2	3	2	3	4	4	4	2	3	3	3	4	60

324	4	4	1	1	4	1	1	4	1	4	4	4	1	1	4	4	1	1	4	4	53
325	3	2	3	3	1	2	4	2	4	3	2	3	2	2	3	2	3	2	1	3	50
326	3	3	3	2	3	1	3	4	2	4	3	3	2	1	3	3	2	2	3	4	54
327	4	4	1	1	4	1	1	4	1	4	4	3	1	1	3	4	3	3	4	4	55
328	3	3	1	4	3	2	4	2	4	2	1	2	3	3	2	2	2	3	2	2	50
329	4	4	1	1	4	1	1	4	1	4	4	1	1	1	4	4	1	1	4	4	50
330	4	4	1	1	4	1	1	4	1	4	4	1	1	1	4	4	1	1	4	4	50
331	3	3	2	1	3	2	3	4	2	3	4	2	1	3	2	3	2	2	3	3	51
332	3	3	2	2	3	2	2	4	2	3	4	2	2	2	3	3	2	2	4	3	53
333	1	2	1	2	4	3	2	4	1	2	1	1	2	4	2	3	3	3	2	4	47
334	3	3	2	2	3	1	3	3	2	3	2	2	2	3	3	3	2	2	3	4	51
335	4	4	4	1	4	1	1	4	1	4	4	1	4	1	4	4	1	1	4	4	56
336	2	1	1	3	1	3	3	1	2	2	2	3	3	3	1	1	4	3	3	1	43
337	4	4	1	1	4	2	2	2	2	4	2	2	2	2	4	2	2	2	2	3	49
338	3	3	2	2	3	2	2	4	2	3	4	2	2	2	3	3	2	2	3	3	52
339	3	3	2	1	3	2	2	4	1	2	4	1	1	3	3	2	1	3	3	3	47
340	3	4	2	2	3	3	2	4	2	3	4	3	2	2	3	4	2	3	3	3	57
341	2	3	1	1	3	1	2	4	2	2	1	2	2	2	2	2	3	3	1	3	42
342	3	4	1	1	3	1	1	4	1	4	3	3	1	2	4	3	1	1	3	4	48
343	3	4	1	1	3	1	2	4	1	4	4	1	1	1	2	3	2	2	3	4	47
344	4	4	1	2	4	1	3	3	3	4	2	4	4	4	4	3	3	3	3	3	62
345	2	4	2	2	4	1	1	2	2	3	3	2	1	2	1	2	2	2	4	3	45
346	3	3	2	1	2	2	1	2	2	3	3	2	2	3	2	3	2	2	2	3	45
347	4	4	1	1	4	1	1	4	1	4	4	1	1	1	4	4	1	1	4	4	50
348	2	3	1	3	2	2	2	2	3	2	1	2	2	3	2	2	3	2	1	2	42
349	3	4	1	1	4	2	2	4	2	4	4	2	1	1	4	2	2	2	4	4	53
350	2	2	2	2	2	2	4	2	2	3	4	4	2	4	2	2	3	3	2	2	51
351	2	3	2	2	2	2	3	2	2	2	2	3	3	3	2	2	2	2	2	2	45
352	3	3	1	1	3	1	3	3	1	4	3	1	1	2	3	3	1	1	3	3	44
353	4	4	1	1	3	1	1	4	1	4	4	1	1	1	4	3	1	1	3	4	47
354	3	4	1	1	3	2	1	4	2	3	2	1	1	1	3	3	1	2	2	3	43
355	2	3	2	2	2	1	4	2	2	3	1	2	2	2	3	1	2	2	3	3	44
356	4	3	1	2	3	1	4	4	2	4	3	4	3	3	3	4	4	2	4	4	62
357	2	2	4	1	2	2	2	2	4	2	3	3	3	3	1	2	2	2	2	2	46
358	3	3	1	1	2	1	2	2	2	3	2	2	2	2	3	2	2	2	2	2	41
359	2	2	2	2	2	2	2	2	2	2	2	2	2	2	2	2	2	2	2	2	40
360	1	3	1	2	4	1	1	4	2	3	3	1	1	2	4	2	2	1	3	4	45
361	2	2	1	1	2	3	2	3	2	3	3	1	2	3	3	2	2	3	3	3	46
362	3	2	2	3	2	3	4	2	4	2	2	3	3	3	2	2	4	4	2	2	54
363	4	3	4	4	3	3	4	4	4	4	3	4	3	3	3	3	4	3	3	4	70
364	3	4	3	1	3	1	3	3	2	3	3	3	2	2	3	3	3	2	2	3	52

365	3	3	3	3	3	3	3	3	4	3	3	3	3	3	3	3	3	3	3	3	61
366	2	3	1	2	3	1	2	2	3	3	1	2	1	1	4	2	1	1	2	3	40
367	4	4	1	1	4	1	1	4	1	4	4	1	1	1	4	3	1	2	3	4	49
368	3	4	1	1	3	3	3	4	3	4	2	3	2	2	3	2	3	3	2	4	55
369	2	3	3	3	3	3	3	3	3	3	3	3	3	3	3	3	3	3	3	3	59
370	4	4	1	1	3	2	3	4	2	4	3	2	1	2	4	2	1	3	3	3	52
371	3	2	2	1	3	1	2	3	2	3	2	2	2	2	3	2	3	3	2	4	47
372	2	3	2	2	2	1	2	1	4	1	2	4	4	4	1	1	2	4	2	2	46
373	4	4	2	1	4	1	2	4	1	4	4	2	1	1	4	4	1	2	4	4	54
374	4	4	3	1	4	1	3	4	1	4	4	3	3	3	3	4	1	1	3	4	58
375	3	3	3	3	3	2	3	3	3	3	4	2	2	3	3	3	2	3	4	4	59
376	2	3	2	3	3	3	4	1	3	2	2	1	3	4	4	1	4	3	2	2	52
377	2	3	1	2	2	3	1	4	2	4	4	3	3	3	3	3	3	3	3	3	55
378	3	4	4	2	2	1	2	3	1	3	3	4	3	2	3	2	3	4	3	4	56
379	3	3	3	2	3	3	3	4	1	4	3	3	3	3	3	3	3	3	3	3	59
380	4	2	3	4	2	1	2	1	1	3	4	2	2	1	1	3	3	1	2	2	44
381	4	4	2	1	4	2	1	4	2	3	4	2	2	1	3	3	2	2	3	4	53
382	2	3	2	1	3	1	3	2	2	3	2	1	1	1	3	2	3	2	3	3	43
383	2	4	1	4	3	3	4	2	4	2	3	3	3	4	3	3	3	4	2	3	60
384	3	3	1	3	3	2	4	3	2	3	3	1	2	2	4	2	3	2	2	3	51
385	2	2	2	2	2	1	3	1	1	2	1	1	2	2	1	1	3	3	2	1	35
386	4	4	1	1	4	1	4	4	1	4	3	2	3	3	4	3	1	1	4	4	56
387	3	3	2	3	3	1	2	3	3	3	3	2	2	2	4	2	3	2	3	3	52
388	3	4	2	1	4	1	1	4	1	4	4	2	2	2	3	3	2	2	3	4	52
389	4	4	2	1	4	1	3	2	1	4	4	2	1	1	4	4	2	2	4	4	54
390	3	3	2	1	3	2	3	3	2	3	2	2	2	2	3	2	2	2	2	3	47
391	3	3	1	1	3	2	2	4	2	3	2	2	1	1	3	3	3	3	4	3	49
392	2	4	2	2	2	1	3	1	2	3	3	3	2	1	3	2	3	2	1	3	45
393	2	3	1	1	4	1	2	4	1	3	4	1	1	1	4	4	1	1	4	4	47
394	1	4	1	1	1	1	1	4	1	4	3	3	1	1	3	3	1	1	3	3	41
395	2	3	2	3	3	3	3	2	3	2	3	4	2	3	2	2	3	3	2	2	52
396	3	4	1	2	3	1	3	3	1	3	2	2	2	3	2	2	2	2	2	2	45
397	3	4	3	1	4	1	3	3	2	4	3	2	3	2	3	3	3	3	3	3	56
398	3	2	2	2	3	4	3	3	2	4	3	4	4	3	2	2	3	3	2	4	58
399	4	4	1	1	4	1	1	4	1	4	3	2	1	1	3	4	1	1	4	4	49
400	3	4	1	3	3	2	2	3	3	4	2	2	2	2	4	3	2	3	3	4	55
401	3	3	2	2	3	4	1	4	3	3	2	1	2	3	3	3	1	2	3	3	51
402	2	4	1	2	2	3	3	4	2	4	3	2	2	2	4	3	2	2	3	4	54
403	3	3	2	2	3	3	2	3	2	3	3	3	2	2	3	3	3	2	3	3	53
404	4	4	1	1	3	1	1	1	1	3	3	3	1	1	4	1	1	4	3	3	44
405	3	3	1	1	3	2	3	4	2	3	3	3	2	3	3	2	3	3	3	3	53

406	2	2	2	1	3	1	4	1	3	3	1	3	4	4	3	2	3	3	2	3	50
407	2	3	1	2	3	4	1	4	1	3	3	2	1	1	3	3	1	1	3	4	46
408	4	4	1	1	3	1	1	3	1	4	4	1	1	1	3	3	1	1	4	3	45
409	3	3	2	2	2	4	2	3	2	2	4	2	2	2	3	2	2	2	3	3	50
410	3	4	1	1	3	2	1	4	3	4	2	2	3	3	3	2	2	2	2	4	51
411	3	3	3	3	2	3	3	2	3	3	3	3	3	3	2	2	3	3	2	3	55
412	2	4	1	2	2	2	2	2	1	2	2	4	2	2	3	3	2	4	1	1	44
413	2	2	2	4	1	3	4	1	4	1	3	2	4	4	2	1	4	4	1	2	51
414	3	4	3	2	4	1	2	4	3	4	4	1	1	3	4	3	2	3	3	4	58
415	4	4	1	1	4	1	3	4	3	4	4	4	4	3	4	4	3	3	3	4	65
416	3	4	2	2	4	4	3	3	2	3	3	4	2	3	3	4	3	3	3	4	62
417	3	4	1	1	3	1	3	4	2	3	3	1	2	1	4	4	2	2	3	2	49
418	2	3	4	2	3	3	1	4	2	2	1	2	1	3	4	3	2	2	2	3	49
419	3	4	1	1	3	2	4	3	1	4	4	1	3	2	4	4	3	2	4	3	56
420	2	3	2	2	2	1	2	2	2	3	2	3	3	3	3	2	3	2	2	3	47
421	2	2	2	3	2	1	1	2	1	2	3	1	1	1	3	1	4	2	4	3	41
422	4	2	2	4	4	1	4	2	1	4	1	4	4	4	4	3	4	4	1	1	58
423	3	3	1	1	3	2	2	4	2	3	2	2	2	3	4	3	2	2	2	3	49
424	3	4	1	1	4	1	4	3	1	3	2	2	1	3	4	3	3	3	1	4	51
425	3	4	3	2	4	1	3	3	3	4	3	3	1	3	4	3	3	3	3	4	60
426	2	3	1	2	2	1	3	2	1	2	4	1	1	2	2	2	2	1	2	4	40
427	3	4	1	1	3	1	2	4	2	3	3	3	1	2	3	3	2	2	2	3	48
428	1	2	3	1	2	3	4	1	4	1	1	4	1	4	1	1	4	4	1	2	45
429	3	2	2	2	1	2	2	2	2	2	4	2	2	2	3	2	2	2	2	2	43
430	3	2	2	1	2	1	2	3	1	3	3	3	2	2	3	3	2	1	2	3	44
431	4	4	2	2	3	1	4	4	3	4	2	1	1	1	4	3	2	2	4	2	53
432	4	4	1	1	3	1	1	4	1	4	3	3	1	1	3	3	1	1	4	4	48
433	3	4	2	3	4	2	1	4	1	4	2	3	3	1	3	3	2	3	3	4	55
434	3	4	2	1	3	1	2	4	1	3	2	1	1	1	3	3	2	1	3	3	44
435	2	1	2	3	1	4	4	1	4	1	3	2	3	3	1	3	3	4	2	1	48
436	1	1	2	1	2	1	2	1	1	1	1	2	2	1	2	1	1	1	1	1	26
437	4	3	2	2	3	1	2	2	2	4	2	2	2	2	3	3	2	2	3	4	50
438	2	3	1	1	3	2	4	3	4	3	3	2	4	2	2	3	4	3	2	2	53
439	4	4	1	1	4	1	2	4	1	3	3	2	1	1	4	3	1	1	3	4	48
440	1	1	1	1	3	1	1	2	1	2	2	1	1	1	3	2	1	2	2	2	31
441	3	4	2	2	2	1	3	2	1	3	3	2	2	2	2	2	2	2	2	3	45
442	3	3	1	3	3	3	3	4	3	4	3	3	2	2	3	3	2	2	4	3	57
443	3	3	1	2	2	1	2	3	2	3	3	1	1	1	3	2	2	2	2	3	42
444	1	1	2	3	2	3	4	2	4	2	1	3	3	3	3	3	3	4	2	2	51
445	3	3	1	1	4	3	2	4	1	4	4	2	2	1	4	3	2	2	4	4	54
446	3	3	3	3	3	2	3	3	2	3	3	2	2	2	3	3	2	2	2	3	52

447	3	3	2	2	3	2	3	4	2	3	3	3	3	3	3	3	3	3	3	3	57
448	3	4	3	2	4	1	2	4	1	4	4	2	1	1	4	4	3	1	4	4	56
449	2	1	1	2	1	2	2	2	2	1	2	2	2	2	2	2	2	2	2	2	36
450	3	3	2	2	3	2	2	3	2	3	2	2	2	2	3	2	2	2	2	3	47
451	2	2	1	3	2	2	4	2	2	2	1	4	2	2	3	2	4	4	2	3	49
452	3	3	3	3	3	1	1	3	2	3	3	2	2	1	4	3	1	1	4	3	49
453	2	2	2	2	2	2	3	2	3	2	2	2	2	3	2	2	2	2	2	2	43
454	3	4	3	3	3	1	2	4	1	3	3	1	1	1	3	3	2	1	2	4	48
455	3	2	2	1	4	2	3	4	1	3	3	3	2	4	4	4	2	3	3	3	56
456	3	3	3	3	3	3	3	3	2	3	3	3	2	2	4	3	3	3	3	3	58
457	4	4	3	1	3	1	1	4	1	4	3	1	1	3	4	3	1	2	3	4	51
458	3	3	3	2	3	2	2	4	3	4	3	2	2	3	4	3	4	4	3	4	61
459	4	4	2	3	4	3	4	4	3	4	4	3	3	3	4	4	3	3	4	4	70
460	3	3	1	2	3	2	3	3	3	3	2	2	2	2	3	3	2	2	2	3	49
461	2	2	1	2	1	2	2	2	2	3	4	3	3	3	3	1	3	3	1	3	46
462	4	3	2	2	4	2	3	4	2	4	4	2	1	2	4	3	2	3	4	4	59
463	3	3	1	2	3	1	3	4	1	4	3	2	2	1	3	4	1	1	4	4	50
464	4	3	3	3	2	4	4	1	3	1	1	3	3	4	3	1	3	3	2	2	53
465	4	4	1	1	4	1	2	4	1	4	4	1	1	1	4	4	1	1	4	4	51
466	4	4	1	1	4	1	2	4	1	4	4	1	1	1	4	4	1	1	4	4	51
467	3	3	1	3	3	2	1	3	1	4	3	2	2	2	3	3	2	2	3	3	49
468	2	2	1	2	2	3	2	2	1	3	4	3	2	2	3	3	3	3	2	3	48
469	2	2	2	2	3	2	4	2	3	3	1	2	3	4	3	3	4	3	3	3	54
470	2	3	1	3	2	4	4	2	3	2	2	1	3	2	1	1	4	3	1	1	45
471	3	2	2	2	2	2	2	2	2	2	2	2	2	2	2	2	2	2	2	2	41
472	3	3	2	3	4	2	2	3	3	4	3	2	3	2	3	2	1	1	4	4	54
473	2	2	2	2	3	1	2	4	2	3	3	2	2	2	3	3	2	2	3	3	48
474	2	3	2	2	3	2	2	2	3	2	2	2	2	2	3	3	2	2	3	3	47
475	3	4	1	2	3	2	2	4	1	4	4	1	3	1	4	4	2	1	4	4	54
476	2	3	2	3	2	2	4	2	3	2	3	4	3	3	2	2	2	4	2	2	52
477	3	3	2	2	3	2	4	3	2	3	2	2	3	3	3	3	3	3	3	3	55
478	3	4	1	2	4	2	2	4	1	4	3	1	3	2	3	4	1	2	3	3	52
479	3	3	4	3	4	2	4	4	2	4	4	4	4	3	4	3	4	4	4	4	71
480	2	3	3	3	3	3	4	3	3	3	2	3	3	3	2	2	3	3	2	2	55
481	2	2	2	2	2	2	2	2	3	2	2	2	2	3	2	2	3	3	2	2	44
482	3	4	1	1	3	4	4	3	3	4	4	1	1	4	4	1	4	4	1	4	58
483	3	4	2	2	4	1	4	4	4	3	2	4	4	1	4	1	4	4	3	2	60
484	3	3	2	1	3	1	3	2	1	3	3	2	1	1	3	2	2	1	2	4	43
485	3	3	2	2	3	2	3	3	2	3	3	2	2	2	3	2	2	2	2	3	49
486	4	4	1	1	4	1	3	4	4	4	4	2	1	2	4	4	2	3	2	4	58
487	3	4	3	2	4	2	1	4	4	4	2	4	3	2	3	1	1	4	2	4	57

488	3	3	2	4	2	3	4	4	3	3	4	2	2	2	3	2	4	4	4	4	62
489	1	3	1	1	3	1	1	4	1	3	3	1	1	1	3	3	1	2	3	3	40
490	1	1	1	2	2	1	4	1	4	2	2	2	2	2	1	2	1	1	2	2	36
491	3	4	1	3	4	1	1	4	1	3	3	2	1	1	3	2	3	1	3	3	47
492	3	2	1	2	2	2	4	3	2	3	2	3	2	2	4	3	2	2	4	3	51
493	3	4	2	4	2	1	4	2	4	2	3	3	4	2	2	2	4	3	3	3	57
494	2	2	3	3	2	3	4	3	3	2	3	2	2	3	3	1	2	3	3	4	53
495	1	2	1	1	2	2	4	1	1	2	4	1	1	2	4	1	2	1	4	3	40
496	3	3	4	3	3	1	2	3	2	3	3	1	1	2	3	2	3	1	1	3	47
497	3	4	3	1	3	2	3	1	2	3	2	2	2	3	1	3	3	4	2	3	50
498	1	2	2	1	1	1	1	1	1	1	1	1	1	1	1	1	1	1	1	1	22
499	3	3	1	1	3	2	4	2	2	3	3	2	3	3	2	2	1	2	3	3	48
500	4	4	1	1	4	1	1	4	1	4	4	1	1	1	4	4	1	1	4	4	50
501	3	4	1	1	4	1	3	1	1	3	3	1	1	1	4	3	2	2	2	3	44
502	3	3	1	2	3	1	3	3	3	3	3	3	2	2	3	3	2	2	3	3	51
503	3	3	2	3	2	2	3	2	2	2	2	2	4	2	2	2	3	3	2	2	48
504	2	2	2	2	2	2	3	2	2	3	2	2	3	3	1	2	3	3	3	1	45
505	2	2	1	1	3	2	4	4	1	2	3	1	1	2	4	2	2	2	3	2	44
506	4	4	1	1	4	1	2	4	1	4	4	1	3	2	1	2	2	1	4	4	50
507	4	4	1	1	4	1	1	4	1	4	4	1	1	1	4	3	1	1	4	4	49
508	2	2	1	2	3	2	3	4	1	4	4	2	2	1	3	3	2	3	3	4	51
509	4	4	2	1	4	1	2	4	1	4	3	2	1	2	3	3	2	1	4	4	52
510	4	4	3	3	4	1	2	4	1	4	3	3	1	1	4	3	1	2	3	4	55
511	4	4	1	1	4	4	2	4	1	4	4	1	1	1	4	2	1	1	4	3	51
512	4	4	1	1	2	1	2	4	2	4	4	2	1	2	1	1	1	1	2	2	43
513	3	3	2	1	3	2	2	3	1	3	3	2	2	2	3	3	2	2	3	4	49
514	4	2	1	1	2	1	4	2	1	3	2	3	1	3	3	2	4	3	2	3	47
515	3	3	2	2	3	1	3	2	2	3	2	2	2	2	3	3	1	1	2	3	45
516	2	2	1	1	4	1	4	2	2	2	2	2	2	2	2	2	2	2	1	2	40
517	2	4	2	2	3	1	4	1	2	3	2	2	2	2	4	1	2	2	2	2	45
518	3	1	3	1	1	2	2	4	1	3	2	3	1	2	3	2	3	1	3	3	44
519	2	2	3	3	2	2	4	2	3	2	2	4	3	3	2	1	2	2	1	2	47
520	2	2	3	3	2	3	1	3	3	1	2	3	2	1	3	1	2	3	2	2	44
521	3	3	2	2	3	2	2	1	2	2	2	2	2	2	3	2	2	3	3	2	45
522	3	3	2	3	2	2	2	3	2	3	4	2	2	2	3	2	2	2	3	3	50
523	2	4	2	1	1	1	1	2	1	3	2	1	1	1	2	1	1	2	2	3	34
524	3	2	1	1	2	1	2	2	2	2	2	2	1	1	2	2	3	3	2	1	37
525	4	4	1	1	4	3	2	3	2	4	3	2	1	1	3	4	2	2	3	4	53
526	2	2	3	3	2	1	2	2	2	2	3	2	2	3	2	3	3	3	2	3	47
527	3	3	2	2	3	2	3	2	2	3	2	2	3	3	2	2	3	2	2	2	48
528	3	2	3	3	3	2	4	3	3	3	4	3	2	3	3	3	2	3	2	3	57

570	4	4	2	1	3	1	2	3	2	3	2	4	3	3	2	4	3	3	3	4	56
571	3	3	2	2	3	2	3	3	2	3	2	2	2	2	3	2	3	3	2	2	49
572	3	4	1	2	3	1	2	4	1	4	3	1	1	2	3	3	2	1	3	4	48
573	3	3	2	2	3	1	1	1	1	3	1	1	1	1	1	1	1	1	1	1	30
574	3	4	1	3	3	4	2	2	1	3	4	2	1	2	4	2	1	1	2	4	49
575	1	1	3	4	2	3	4	2	4	3	2	2	2	3	4	3	4	2	2	2	53
576	4	4	1	1	4	1	2	4	1	4	4	4	2	2	1	4	4	1	4	4	56
577	3	3	1	1	4	1	1	3	1	4	4	3	1	1	4	3	3	3	4	4	52
578	3	3	2	2	3	1	1	3	2	2	3	2	1	1	2	3	1	1	4	4	44
579	3	1	2	3	2	1	1	2	3	3	3	2	4	3	2	1	2	3	2	2	45
580	2	3	1	1	3	2	1	4	2	3	3	2	2	2	3	3	2	3	3	3	48
581	3	3	2	2	2	1	3	2	2	2	3	2	2	2	2	2	2	2	2	3	44
582	3	3	1	1	2	1	2	2	1	3	3	1	1	1	4	2	2	1	2	3	39
583	3	3	2	2	3	2	2	2	3	2	3	4	2	2	2	2	2	3	1	1	46
584	2	3	2	2	3	2	4	1	4	2	2	1	3	3	2	1	4	4	2	3	50
585	3	3	2	2	3	1	3	2	2	3	3	1	1	1	3	3	1	2	2	1	42
586	3	3	2	3	3	2	3	3	1	1	1	1	1	1	1	1	1	2	2	2	37
587	4	4	1	1	4	1	1	2	1	4	4	1	1	1	4	4	1	1	4	4	48
588	3	4	1	3	3	3	4	3	2	2	3	1	2	2	3	1	1	2	2	2	47
589	1	4	1	3	2	2	4	2	4	3	2	1	1	4	2	1	3	1	2	1	44
590	3	4	1	1	3	2	3	3	2	3	3	2	1	1	3	3	1	1	3	3	46
591	3	3	2	3	2	2	2	3	4	2	3	3	4	3	2	3	4	3	3	3	57
592	3	3	3	2	3	2	1	2	2	3	3	1	1	1	2	3	2	2	3	3	45
593	3	3	1	2	3	1	1	4	1	3	4	1	1	1	4	2	1	1	3	3	43
594	4	4	1	1	4	1	1	4	1	4	4	1	1	1	4	4	1	1	4	4	50
595	3	3	3	3	2	2	3	4	2	3	3	3	2	2	3	3	3	3	2	3	55
596	2	3	3	1	2	2	1	2	4	2	2	3	3	3	2	3	4	4	1	1	48
597	4	4	3	3	3	4	2	4	3	3	1	3	3	3	3	3	2	3	3	3	60
598	4	4	4	4	4	4	4	4	4	4	4	4	4	4	4	4	4	4	4	4	80
599	4	4	4	4	4	4	4	1	3	2	2	1	1	1	1	1	1	2	1	1	46
600	3	3	1	1	3	1	1	3	1	3	3	1	1	1	3	3	1	1	3	3	40
601	1	1	1	1	1	1	1	1	1	1	1	1	1	1	1	1	1	1	1	1	20
602	2	1	3	3	3	3	3	3	4	2	3	3	3	3	1	4	4	4	1	2	55
603	1	4	2	1	3	2	2	3	3	3	1	2	3	2	3	2	3	3	2	2	47
604	3	2	2	1	3	1	3	4	1	3	3	1	1	3	3	3	2	3	3	3	48
605	3	3	2	2	3	2	2	3	2	3	3	2	2	2	3	3	2	2	3	3	50
606	2	2	2	2	2	1	1	2	2	2	3	1	2	2	3	2	2	1	4	2	40
607	4	4	1	1	4	1	1	4	1	4	4	1	1	1	4	4	1	1	4	4	50
608	1	3	2	3	1	4	4	1	3	3	2	3	4	3	2	1	4	3	2	1	50
609	4	4	1	1	4	1	1	1	1	1	1	1	1	1	4	4	1	3	3	1	39
610	3	3	1	1	2	1	1	2	1	3	2	1	1	2	3	3	1	1	3	3	38

652	2	2	1	3	4	3	2	1	3	2	2	3	2	3	2	1	4	2	1	2	45
653	2	4	3	3	3	2	2	1	4	2	3	4	3	2	3	3	2	2	2	2	52
654	3	3	1	3	2	1	1	3	1	3	2	3	1	1	3	2	2	2	2	2	41
655	3	4	1	1	3	4	4	4	4	4	2	4	3	3	3	2	4	4	1	1	59
656	3	2	1	2	3	2	3	2	4	2	1	4	4	4	2	2	4	2	2	3	52
657	2	4	1	1	3	2	4	3	1	3	4	2	2	2	4	2	3	3	2	3	51
658	4	4	3	3	4	4	2	4	2	4	4	2	3	3	3	3	3	3	3	3	64
659	2	3	2	3	2	3	2	2	4	2	2	2	3	2	2	2	3	2	3	2	48
660	3	3	1	1	3	4	1	4	2	3	3	1	1	1	3	3	1	1	2	3	44
661	3	3	2	1	3	1	2	4	1	3	3	1	1	1	3	3	1	1	3	4	44
662	4	3	2	3	4	3	4	4	4	4	4	4	4	4	4	4	4	4	4	4	75
663	4	4	4	4	4	4	4	4	4	4	4	4	4	4	4	4	4	4	4	4	80
664	3	3	4	4	2	1	4	4	3	2	4	4	3	2	4	3	2	1	4	3	60
665	4	4	1	1	1	1	1	2	3	2	4	1	1	2	1	4	1	1	1	1	37
666	1	3	2	1	2	3	2	3	1	4	2	1	3	2	1	4	1	3	2	2	43
667	3	4	3	2	3	2	2	2	1	4	4	4	4	4	3	3	2	3	4	3	60
668	4	3	3	4	4	4	4	4	3	3	2	2	2	1	2	3	4	2	2	3	59
669	4	4	4	3	3	3	2	2	1	1	4	4	4	4	4	4	4	3	4	4	66
670	3	3	3	3	4	4	4	3	3	3	3	2	2	1	1	1	4	4	3	3	57
671	3	3	3	3	3	3	3	4	3	4	4	2	2	2	2	1	1	1	1	1	49
672	4	3	3	4	3	3	2	1	4	4	4	4	3	2	2	3	4	4	4	4	65
673	4	4	2	2	2	2	2	4	3	3	4	2	2	2	3	2	2	2	3	3	53
674	3	3	2	2	3	2	3	4	2	3	3	2	3	3	3	3	3	3	3	2	55
675	3	3	2	2	2	2	2	4	2	2	2	2	2	2	2	2	2	2	2	3	45
676	2	2	3	3	2	3	4	3	2	2	2	3	3	3	2	2	2	3	2	2	50
677	3	3	2	4	3	3	3	3	3	3	2	3	2	3	2	3	2	2	4	4	57
678	3	3	2	2	3	1	2	4	1	4	4	1	1	1	4	3	2	2	4	4	51
679	4	4	2	1	4	1	2	4	1	3	4	1	1	1	4	4	1	1	4	4	51
680	3	3	1	1	4	1	3	4	3	4	3	4	3	3	3	3	3	3	3	3	58
681	4	4	1	1	4	3	3	4	1	4	4	3	1	3	4	4	3	3	4	4	62
682	4	4	3	3	2	2	4	2	3	2	1	1	1	1	4	1	1	1	1	1	42
683	2	4	2	2	2	1	3	4	2	2	2	2	2	2	2	3	1	2	3	4	47
684	4	4	2	2	4	2	3	4	2	4	4	2	2	2	4	4	2	2	4	4	61
685	3	3	3	4	4	3	3	4	3	3	3	3	3	3	3	3	3	3	3	3	63
686	4	4	1	1	4	1	1	4	1	4	4	1	1	1	3	3	1	1	4	4	48
687	1	3	1	3	3	3	1	1	1	3	4	1	2	2	1	3	3	1	4	3	44
688	2	4	3	3	3	3	4	3	4	3	3	3	3	3	3	3	3	3	3	3	62
689	3	4	1	1	3	3	3	3	3	4	4	2	2	2	3	3	4	4	3	3	58
690	3	3	1	1	3	2	2	4	1	4	4	1	1	1	4	3	1	2	3	3	47
691	3	3	3	3	3	2	2	4	2	3	4	2	2	2	3	3	2	2	4	4	56
692	4	4	2	1	4	1	1	4	1	4	4	1	1	1	3	4	1	1	4	4	50

734	1	1	1	1	1	3	1	1	1	2	3	1	1	1	4	1	1	1	2	2	30
735	4	1	1	2	3	1	2	3	2	2	3	3	3	2	4	2	3	3	3	3	50
736	3	4	3	2	3	3	4	4	2	3	1	4	2	3	3	3	4	4	2	3	60
737	4	4	1	1	4	1	2	4	1	4	4	1	1	1	4	3	1	1	4	4	50
738	3	2	1	4	2	4	4	4	4	4	1	4	4	4	4	1	4	4	2	4	64
739	1	2	2	1	2	3	2	2	3	2	3	1	1	2	3	2	2	3	2	1	40
740	3	3	2	2	3	1	3	3	2	3	2	2	1	2	3	3	2	2	3	3	48
741	4	4	1	1	3	2	4	3	1	4	3	2	1	3	4	3	1	3	3	4	54
742	3	3	2	2	3	1	2	4	1	3	3	2	2	2	4	2	2	1	2	3	47
743	1	3	3	2	2	2	2	1	1	3	4	2	3	4	4	1	3	1	4	2	48
744	3	3	3	2	3	3	3	3	2	3	3	3	2	3	3	2	2	4	4	4	58
745	3	3	3	3	3	2	2	3	2	3	2	3	2	3	3	3	3	3	2	3	54
746	3	3	1	1	3	1	2	4	2	3	3	1	2	2	3	3	2	1	3	4	47
747	4	1	1	1	4	1	2	2	1	4	4	1	4	2	3	2	1	1	4	4	47
748	3	4	3	2	3	2	3	2	1	3	3	2	2	3	2	2	2	3	2	2	49
749	3	3	2	2	4	3	3	3	2	3	3	2	2	2	3	2	2	2	3	4	53
750	2	3	1	3	2	2	2	2	2	3	2	3	2	2	2	2	3	3	2	2	45
751	4	4	1	1	4	1	1	4	1	4	4	1	1	1	4	4	1	1	4	4	50
752	2	3	1	1	3	2	4	3	2	2	2	1	2	3	2	2	3	2	3	3	46
753	4	3	2	3	3	1	3	3	2	4	3	2	2	3	3	3	2	2	3	3	54
754	3	3	2	3	2	1	1	1	1	2	3	1	2	1	1	2	3	2	2	3	39
755	4	1	1	1	1	4	1	4	1	4	4	1	1	2	4	1	1	1	4	4	45
756	3	3	3	1	3	1	2	3	2	3	3	3	3	3	3	3	3	2	4	4	55
757	4	4	1	1	3	1	1	3	1	3	3	2	1	2	4	3	2	1	4	4	48
758	3	2	2	2	2	1	1	3	1	2	3	2	2	1	3	2	1	3	2	3	41
759	3	3	2	1	3	1	2	3	1	3	3	2	2	2	3	3	1	2	3	3	46
760	2	3	1	2	3	1	2	3	2	3	1	2	2	2	3	1	2	3	1	3	42
761	3	3	2	2	3	1	2	3	2	3	3	2	1	2	3	2	2	2	2	3	46
762	3	3	3	2	3	1	3	4	1	3	2	2	1	2	3	3	2	2	3	3	49
763	3	2	1	1	3	2	3	4	3	3	3	3	2	2	1	3	3	3	3	3	51
764	2	3	1	3	3	1	2	3	1	3	1	2	4	1	3	1	2	2	1	3	42
765	3	2	1	3	3	2	3	2	2	3	3	1	1	1	3	2	2	4	3	3	47
766	3	3	1	3	3	1	2	3	1	3	1	2	4	1	3	1	1	2	1	3	42
767	2	3	2	2	2	1	2	1	3	2	2	1	3	2	2	2	3	4	2	2	43
768	2	1	4	1	2	1	3	3	1	3	1	1	1	1	4	1	1	2	1	2	36
769	3	4	1	1	3	1	1	1	1	3	3	2	1	1	3	1	1	2	3	2	38
770	3	3	1	3	2	1	4	4	1	4	1	1	1	3	4	1	1	1	1	4	44
771	3	2	2	1	3	2	1	3	2	2	4	2	2	2	2	2	2	2	4	3	46
772	3	3	1	1	3	3	3	3	2	3	2	2	1	1	4	3	2	4	2	3	49
773	3	3	2	2	3	2	1	4	3	3	3	3	3	2	4	4	3	3	3	3	57
774	4	2	3	2	2	2	4	2	3	1	2	4	4	2	1	1	3	3	1	1	47

775	2	3	3	3	2	3	4	2	3	2	2	4	3	4	2	2	3	4	2	3	56
-----	---	---	---	---	---	---	---	---	---	---	---	---	---	---	---	---	---	---	---	---	----

Data Dukungan Sosial

No. Responden	Y 1	Y 2	Y 3	Y 4	Y 5	Y 6	Y 7	Y 8	Y 9	Y1 0	Y1 1	Y1 2	Dukungan sosial
1	7	7	7	7	4	1	4	2	1	7	7	7	61
2	7	7	6	7	6	6	6	6	4	6	4	3	68
3	6	6	6	6	6	6	7	5	6	6	7	7	74
4	4	5	3	4	6	5	7	6	7	7	7	7	68
5	6	6	3	3	7	5	7	4	6	6	6	6	65
6	7	4	6	6	4	4	4	4	3	3	3	3	51
7	7	6	4	4	4	4	4	3	5	4	3	4	52
8	6	5	3	4	5	5	4	4	4	6	6	7	59
9	6	6	6	5	5	5	6	6	6	6	6	6	69
10	6	6	5	5	5	5	5	7	5	6	6	6	67
11	7	7	7	5	4	4	4	2	6	4	4	4	58
12	7	7	2	7	6	4	7	4	4	7	7	7	69
13	7	7	4	7	7	5	7	6	5	6	6	4	71
14	7	6	6	6	4	3	3	3	1	1	1	1	42
15	6	4	1	4	4	3	3	1	1	1	3	1	32
16	7	5	4	5	4	3	4	4	3	3	3	3	48
17	7	7	7	7	5	4	4	4	4	4	4	4	61
18	7	7	6	7	6	6	6	6	6	6	4	4	71
19	7	7	7	7	7	7	7	7	7	7	7	7	84
20	6	4	2	6	4	5	4	5	2	2	2	4	46
21	7	4	5	6	6	6	6	6	6	6	4	4	66
22	7	6	6	7	6	6	6	4	6	6	7	7	74
23	6	3	7	6	5	6	5	1	1	1	1	1	43
24	7	7	7	7	7	7	7	7	7	7	7	7	84
25	5	4	4	4	5	5	4	4	7	7	7	7	63
26	4	7	7	6	7	6	6	6	6	2	4	4	65
27	3	1	1	2	3	3	5	1	7	7	7	7	47
28	4	4	1	5	4	2	4	4	4	4	4	2	42
29	6	4	6	5	4	4	5	5	5	6	5	5	60
30	7	6	6	7	5	5	6	6	7	7	7	7	76
31	5	5	4	4	5	4	5	5	4	7	7	7	62
32	7	7	7	7	6	6	6	6	6	6	6	6	76
33	7	1	6	7	6	7	7	6	7	6	7	7	74
34	7	7	7	7	7	6	7	6	7	7	7	7	82
35	6	6	6	4	4	4	6	6	6	6	4	6	64
36	6	4	5	6	4	5	4	4	6	4	4	5	57
37	7	6	7	7	4	5	1	2	4	6	1	4	54

38	4	4	4	4	4	1	4	4	7	7	7	7	57
39	7	5	4	5	7	7	7	7	7	7	7	5	75
40	7	6	4	6	7	7	7	7	7	7	7	7	79
41	6	6	4	4	5	4	6	6	6	6	6	6	65
42	7	6	5	5	6	5	6	5	5	5	5	5	65
43	7	7	7	6	4	4	6	4	3	3	4	3	58
44	7	5	5	4	6	5	6	2	6	6	5	4	61
45	7	6	4	5	4	4	4	6	3	3	3	4	53
46	6	7	7	4	7	4	7	4	5	5	5	5	66
47	6	6	2	4	7	7	7	6	7	7	7	7	73
48	5	5	4	6	4	4	4	3	5	5	4	4	53
49	4	7	4	4	7	7	7	7	7	7	7	7	75
50	7	7	6	6	6	7	7	6	7	6	7	6	78
51	4	4	1	4	6	4	6	3	7	6	2	6	53
52	7	7	6	7	7	7	7	4	4	5	3	3	67
53	7	7	6	6	6	6	7	5	5	5	5	5	70
54	7	7	6	7	6	4	6	6	4	6	4	4	67
55	6	5	6	6	5	5	6	5	4	4	4	1	57
56	7	7	4	6	6	5	7	6	6	6	6	7	73
57	6	5	7	6	6	5	6	6	7	7	7	7	75
58	7	4	5	6	6	4	6	6	4	5	3	4	60
59	1	7	7	7	7	7	5	2	6	7	3	7	66
60	7	2	1	6	1	5	7	6	7	1	1	7	51
61	6	1	4	7	4	4	4	4	5	4	5	4	52
62	7	7	5	7	6	6	6	6	6	5	4	6	71
63	7	7	5	7	6	6	6	6	5	4	4	4	67
64	7	5	4	4	6	5	5	5	7	7	7	4	66
65	7	5	4	4	6	5	5	5	4	4	4	4	57
66	7	6	6	7	5	5	6	6	6	7	7	6	74
67	6	6	5	7	6	5	6	3	3	3	6	6	62
68	7	4	7	7	4	4	5	7	7	7	1	1	61
69	7	1	6	7	5	3	5	3	4	6	6	6	59
70	7	7	7	7	6	5	6	6	7	7	7	7	79
71	7	4	6	6	4	4	4	4	7	7	7	7	67
72	7	6	6	7	7	7	7	7	2	2	2	5	65
73	6	2	1	3	6	2	6	6	6	3	6	4	51
74	6	4	2	4	6	6	4	4	4	4	4	6	54
75	7	7	4	4	6	4	5	4	6	6	7	7	67
76	6	6	3	7	5	6	6	4	7	7	6	6	69
77	7	7	5	5	3	4	6	6	7	7	7	7	71
78	7	6	3	7	5	4	7	7	6	6	6	6	70

79	6	7	6	7	6	6	6	6	6	6	6	6	74
80	3	2	5	5	3	2	2	3	3	4	2	3	37
81	7	4	3	4	3	3	4	2	6	6	6	6	54
82	7	7	7	7	6	5	6	5	5	5	5	6	71
83	4	4	4	4	2	2	1	2	7	7	7	7	51
84	4	4	2	4	4	6	5	4	2	4	4	3	46
85	7	7	5	7	7	7	7	5	7	5	6	6	76
86	3	4	6	4	6	6	4	4	6	6	5	7	61
87	6	4	3	5	6	6	7	6	6	6	7	6	68
88	7	7	7	7	7	4	4	4	4	4	4	5	64
89	7	7	7	7	7	7	7	5	6	7	3	7	77
90	7	4	1	4	3	4	2	1	2	1	4	4	37
91	7	5	2	3	4	2	6	4	3	6	7	7	56
92	7	7	7	7	7	7	4	4	4	7	6	7	74
93	7	5	4	3	4	4	5	4	4	4	3	7	54
94	7	7	7	7	6	6	6	4	4	4	4	4	66
95	4	6	7	5	4	5	5	4	7	7	7	7	68
96	4	4	4	4	4	4	4	4	4	4	4	4	48
97	7	7	7	7	7	7	7	7	7	7	7	7	84
98	7	7	4	3	6	7	7	7	7	7	7	7	76
99	6	7	4	4	4	4	4	4	4	4	4	4	53
100	4	2	2	4	4	1	3	3	4	3	4	3	37
101	6	6	6	7	4	4	4	4	4	7	6	6	64
102	6	6	6	6	4	2	7	4	6	7	6	5	65
103	7	7	7	7	7	7	7	7	7	7	7	7	84
104	7	5	6	6	4	3	6	6	2	5	2	3	55
105	7	7	6	4	3	4	4	3	6	6	4	4	58
106	4	3	1	4	3	6	4	2	4	4	1	1	37
107	7	7	5	7	6	6	6	1	6	7	5	7	70
108	7	5	4	7	7	6	7	6	7	7	7	7	77
109	6	5	4	5	6	5	6	6	6	4	5	6	64
110	4	4	4	4	4	4	4	4	4	4	4	4	48
111	4	7	1	1	5	1	7	5	7	5	5	5	53
112	4	4	4	4	4	4	4	4	4	4	4	4	48
113	7	7	1	1	7	7	7	7	7	7	7	7	72
114	7	6	4	7	5	1	2	1	2	1	1	3	40
115	6	6	4	4	4	5	5	5	6	5	5	4	59
116	6	6	4	5	6	4	4	4	4	4	4	4	55
117	6	3	1	4	6	6	6	6	6	6	6	6	62
118	7	5	4	7	4	2	3	2	7	7	7	7	62
119	7	7	7	7	6	6	6	6	5	7	1	6	71

120	7	7	2	7	4	1	5	5	4	4	7	7	60
121	6	4	5	6	7	7	7	7	7	7	7	5	75
122	7	7	7	7	6	6	7	7	7	7	7	7	82
123	7	5	7	6	2	5	1	7	5	4	7	7	63
124	4	4	6	6	5	5	6	5	4	4	4	4	57
125	7	7	7	7	7	5	6	6	7	7	7	7	80
126	4	4	3	3	4	4	7	6	7	7	3	3	55
127	7	7	7	7	7	5	7	7	7	7	7	7	82
128	7	7	7	7	5	4	5	6	7	7	7	7	76
129	6	6	7	6	4	4	6	5	3	4	2	3	56
130	7	6	6	7	6	6	7	6	6	6	6	6	75
131	7	7	5	6	2	2	1	3	7	7	7	7	61
132	4	2	1	2	3	2	3	3	2	3	3	3	31
133	7	4	6	6	6	5	6	6	6	6	6	6	70
134	4	4	6	5	6	2	5	3	5	5	4	4	53
135	4	4	6	5	6	2	5	3	5	5	4	4	53
136	7	7	7	7	7	7	7	7	7	7	7	7	84
137	6	5	3	4	4	4	4	4	4	4	4	4	50
138	7	7	7	6	5	5	6	6	6	6	5	6	72
139	7	6	6	5	6	4	6	5	5	6	6	5	67
140	7	7	7	7	5	1	7	7	7	7	7	7	76
141	7	6	6	7	6	6	7	6	6	6	6	6	75
142	5	1	1	1	4	4	1	1	1	1	1	1	22
143	7	7	7	7	7	7	7	7	7	7	7	7	84
144	6	5	5	6	4	4	6	5	6	6	5	4	62
145	7	4	2	5	7	6	6	7	1	3	4	5	57
146	6	4	3	4	4	6	4	5	7	7	7	7	64
147	7	7	4	6	7	6	7	7	7	7	7	7	79
148	6	6	6	6	6	6	6	6	7	6	7	6	74
149	7	7	7	7	7	7	7	7	7	7	7	7	84
150	7	6	6	6	6	6	6	6	1	1	6	5	62
151	6	5	5	7	6	6	6	4	1	1	2	4	53
152	7	7	7	6	4	5	6	6	6	6	6	5	71
153	6	4	4	4	6	6	4	4	4	4	4	4	54
154	7	4	3	4	7	7	7	7	7	7	6	7	73
155	7	7	2	4	5	5	5	3	3	2	1	3	47
156	7	7	4	7	7	7	7	7	7	7	6	7	80
157	7	6	1	5	4	3	6	5	5	6	1	1	50
158	7	7	4	7	5	7	4	2	2	4	4	2	55
159	7	4	5	6	5	5	4	3	5	5	5	5	59
160	4	4	4	4	5	3	5	4	5	4	3	5	50

161	6	6	6	6	6	6	6	6	6	6	6	6	72
162	7	4	5	3	3	2	2	2	2	4	4	4	42
163	2	1	1	1	4	1	3	3	3	5	5	7	36
164	5	7	3	5	5	3	6	5	1	1	1	1	43
165	7	7	7	7	7	7	7	7	7	7	7	7	84
166	4	5	1	5	7	7	7	7	7	7	7	7	71
167	7	7	7	7	6	6	6	6	7	7	7	7	80
168	7	4	5	5	4	4	4	5	4	4	5	4	55
169	4	4	4	4	4	4	4	4	4	4	4	4	48
170	7	5	2	2	2	2	5	4	7	7	7	7	57
171	7	7	7	7	5	4	4	5	4	7	7	7	71
172	7	7	1	4	7	7	7	7	7	7	7	7	75
173	3	3	3	3	5	5	5	5	5	5	5	5	52
174	4	4	6	7	7	7	7	5	5	5	5	5	67
175	7	7	7	7	7	7	7	7	7	7	7	7	84
176	3	2	1	2	4	4	4	2	2	3	1	1	29
177	7	7	7	7	7	7	7	7	7	7	7	7	84
178	7	7	7	7	7	7	7	7	7	7	7	7	84
179	7	7	7	7	7	5	7	5	1	1	1	1	56
180	3	2	1	2	4	2	2	2	3	2	2	2	27
181	7	7	5	5	6	4	7	4	7	7	7	6	72
182	4	4	1	4	4	1	7	5	7	7	4	5	53
183	7	7	4	7	7	4	7	7	4	4	4	3	65
184	6	1	1	4	4	3	4	2	5	5	5	2	42
185	6	3	6	6	3	3	3	3	6	6	6	6	57
186	4	7	1	1	2	4	1	2	7	7	7	6	49
187	6	4	4	4	5	6	5	4	7	4	4	5	58
188	3	4	3	3	4	4	4	4	6	6	6	6	53
189	5	6	5	5	5	7	1	1	5	1	1	1	43
190	4	4	4	4	4	4	4	4	4	4	4	4	48
191	4	4	4	4	4	4	4	4	4	4	4	4	48
192	4	4	3	5	5	5	7	6	7	6	7	7	66
193	5	6	3	5	6	6	5	6	6	7	7	7	69
194	6	4	5	5	4	4	7	5	7	7	7	7	68
195	2	4	1	1	1	1	1	1	5	1	1	4	23
196	7	7	3	7	7	6	4	6	7	7	7	7	75
197	7	7	7	7	5	5	5	5	7	7	6	7	75
198	7	5	4	4	7	6	6	7	6	6	4	4	66
199	7	6	5	6	6	6	7	7	7	7	7	7	78
200	7	4	4	4	4	6	6	4	6	6	5	5	61
201	4	3	2	4	4	4	7	6	7	7	7	7	62

202	4	3	2	4	3	3	4	4	2	3	3	3	38
203	5	4	3	4	3	1	4	4	5	3	5	4	45
204	4	4	1	4	6	4	5	4	7	6	6	6	57
205	3	1	1	2	6	6	7	7	6	6	6	7	58
206	6	4	4	4	4	4	4	4	4	4	4	4	50
207	4	4	2	4	6	6	6	7	6	6	4	3	58
208	7	6	7	7	5	4	7	5	7	7	7	7	76
209	7	7	7	7	7	7	7	7	7	7	7	7	84
210	6	6	5	6	3	3	3	3	3	3	3	3	47
211	6	7	6	7	7	7	7	6	6	7	5	3	74
212	5	6	5	5	4	4	5	5	7	6	4	4	60
213	6	5	5	6	6	5	7	6	2	4	2	4	58
214	7	7	2	3	4	4	4	4	4	5	6	6	56
215	4	4	4	4	4	5	6	6	5	6	6	6	60
216	4	4	4	4	3	5	2	2	4	4	4	4	44
217	7	7	7	7	4	6	7	7	7	7	7	7	80
218	7	7	7	7	7	7	7	7	7	7	7	7	84
219	7	6	4	6	6	6	7	5	6	6	2	3	64
220	7	6	7	7	5	5	5	5	4	4	4	4	63
221	6	4	2	4	4	4	7	6	2	7	4	4	54
222	4	4	1	3	5	5	7	7	5	6	7	4	58
223	7	6	6	6	7	7	7	6	4	4	4	4	68
224	6	6	3	4	4	4	6	4	6	6	4	5	58
225	3	3	1	5	4	3	4	4	2	4	1	1	35
226	7	7	6	6	7	6	7	7	6	6	6	6	77
227	7	6	4	6	4	2	4	6	7	7	7	7	67
228	7	1	7	7	4	3	4	4	7	7	7	7	65
229	7	6	7	7	4	5	5	5	7	7	7	7	74
230	7	4	2	4	1	1	1	1	6	3	6	4	40
231	6	6	3	6	4	6	4	6	4	4	5	5	59
232	7	7	4	6	6	6	6	4	6	3	7	7	69
233	7	7	7	7	6	6	7	7	7	6	7	4	78
234	7	6	4	4	4	1	4	4	7	7	7	7	62
235	7	6	6	5	6	6	6	7	1	1	6	1	58
236	6	3	2	4	6	5	6	4	6	6	4	7	59
237	6	6	7	7	4	4	3	2	7	7	6	7	66
238	4	5	2	4	4	3	4	4	3	4	3	3	43
239	4	2	1	3	4	6	6	5	4	5	5	4	49
240	6	4	1	5	4	2	2	5	1	1	1	1	33
241	4	2	2	2	6	7	6	6	2	4	2	2	45
242	6	6	6	6	7	7	7	6	7	7	7	6	78

243	3	2	1	2	3	3	3	2	1	1	1	1	23
244	6	6	5	6	4	5	6	4	3	6	5	5	61
245	6	6	6	6	4	4	4	4	2	4	2	4	52
246	6	4	2	5	4	4	4	4	6	7	7	7	60
247	3	3	4	4	6	6	7	7	1	4	1	1	47
248	6	4	4	6	4	4	4	6	4	4	4	6	56
249	4	4	3	4	5	4	4	4	4	5	5	5	51
250	7	7	4	4	4	3	3	4	3	3	3	3	48
251	6	6	5	5	4	4	5	4	1	1	1	1	43
252	7	6	4	4	7	7	4	4	1	3	1	3	51
253	5	5	6	6	6	5	7	5	4	4	4	4	61
254	7	7	6	6	5	5	6	5	5	7	5	6	70
255	5	5	6	6	4	4	6	5	6	6	6	5	64
256	7	6	4	6	7	7	7	7	7	7	7	2	74
257	6	4	3	5	7	7	7	6	6	6	4	6	67
258	6	5	6	7	6	4	6	4	7	7	7	7	72
259	6	5	5	6	6	6	6	7	6	6	6	6	71
260	5	2	7	5	2	2	7	5	3	7	5	5	55
261	6	3	1	3	7	7	7	7	7	7	7	7	69
262	7	4	4	4	6	4	7	7	7	7	7	7	71
263	7	5	3	4	4	5	6	5	4	4	4	4	55
264	7	4	1	4	4	1	4	4	4	3	4	4	44
265	4	4	3	4	4	4	7	7	7	7	4	7	62
266	4	7	2	5	5	5	4	3	1	4	1	1	42
267	7	7	7	7	6	7	7	7	7	7	7	7	83
268	6	2	6	6	6	2	6	6	6	6	6	6	64
269	7	7	7	7	6	4	3	3	7	7	4	7	69
270	6	6	6	6	6	6	6	6	6	6	6	6	72
271	7	7	7	7	7	7	7	7	7	7	7	7	84
272	7	6	5	7	6	6	7	6	5	7	7	7	76
273	7	7	7	7	7	4	7	3	5	7	7	4	72
274	7	7	5	7	6	6	6	5	4	5	3	5	66
275	7	6	4	7	7	7	7	4	5	4	4	7	69
276	4	6	7	5	4	3	4	4	5	5	4	7	58
277	6	6	4	4	5	5	7	6	5	6	2	3	59
278	4	4	3	5	4	5	4	4	6	6	4	4	53
279	7	6	2	6	7	2	7	6	6	7	7	7	70
280	3	3	1	1	7	7	7	7	7	7	7	7	64
281	7	6	1	6	6	5	6	4	3	4	1	3	52
282	6	5	4	5	4	4	5	6	4	5	5	6	59
283	5	4	3	4	4	4	5	4	5	5	5	5	53

284	4	4	2	4	4	4	4	4	4	3	2	2	41
285	7	7	2	3	3	2	6	2	7	7	7	7	60
286	7	7	4	7	7	7	7	7	7	7	7	7	81
287	7	4	4	6	4	4	6	4	7	7	6	7	66
288	7	4	4	7	4	5	4	4	5	5	5	5	59
289	7	6	6	6	4	4	4	4	4	6	6	6	63
290	7	6	4	6	6	6	7	7	7	7	7	7	77
291	5	5	1	4	4	6	6	6	5	5	5	5	57
292	6	6	6	6	6	5	6	5	7	7	7	7	74
293	4	3	6	3	2	4	5	6	7	6	6	7	59
294	6	2	7	6	6	6	6	6	6	6	6	6	69
295	5	4	1	4	6	4	3	2	7	2	4	7	49
296	7	6	2	6	2	2	6	5	1	5	3	5	50
297	6	4	4	4	4	5	5	4	4	4	4	4	52
298	6	6	6	6	6	6	7	7	7	7	7	7	78
299	7	7	6	7	7	5	7	7	7	7	7	7	81
300	7	4	7	7	4	4	4	4	7	7	7	7	69
301	7	7	7	5	6	5	3	3	7	5	5	7	67
302	3	3	2	3	5	7	6	6	4	7	4	6	56
303	4	3	1	5	6	4	6	3	7	7	6	6	58
304	7	1	6	6	7	1	7	7	6	6	7	6	67
305	7	7	6	7	5	4	4	3	4	7	7	7	68
306	4	3	1	2	7	6	6	7	7	7	7	7	64
307	7	7	4	5	4	6	4	2	2	2	2	4	49
308	7	7	5	7	6	6	7	7	6	7	6	6	77
309	6	6	3	6	7	7	7	7	6	6	6	6	73
310	7	6	2	4	4	4	5	5	2	4	3	4	50
311	7	6	6	6	5	5	6	5	6	6	6	6	70
312	5	4	5	4	5	5	5	5	6	6	6	5	61
313	7	7	4	6	6	6	7	6	7	7	4	4	71
314	7	7	7	7	7	7	7	7	6	7	7	7	83
315	7	6	4	6	5	4	5	5	4	4	4	4	58
316	6	5	3	7	5	5	1	1	5	1	1	1	41
317	6	6	4	6	4	6	4	5	7	7	7	7	69
318	7	7	7	7	1	6	6	6	7	6	7	7	74
319	4	5	4	4	4	4	6	6	5	7	4	4	57
320	7	7	4	4	6	5	5	4	6	4	5	4	61
321	4	3	4	4	4	4	4	1	4	4	4	4	44
322	7	7	7	7	7	7	7	7	1	4	1	1	63
323	7	6	6	6	7	7	7	7	2	4	2	3	64
324	7	7	7	7	7	5	7	7	5	7	7	5	78

325	4	6	4	7	6	3	4	2	2	4	5	6	53
326	2	2	1	2	5	5	6	6	7	7	7	6	56
327	7	7	6	5	4	4	4	4	5	5	6	6	63
328	4	2	1	4	1	2	2	1	1	1	1	1	21
329	7	4	7	7	7	4	7	4	4	4	4	4	63
330	7	4	4	7	4	4	6	4	4	4	4	4	56
331	6	6	2	4	4	4	6	5	6	6	6	6	61
332	7	6	4	6	4	4	6	2	4	5	5	6	59
333	4	2	3	4	3	2	1	4	7	2	5	4	41
334	6	6	4	6	6	4	6	4	3	3	3	3	54
335	7	1	7	7	7	7	7	7	7	7	7	7	78
336	4	7	4	7	7	5	4	3	1	4	1	1	48
337	7	7	7	7	4	4	2	2	4	4	4	4	56
338	5	4	4	5	5	4	5	5	5	4	5	5	56
339	6	5	3	4	6	6	7	7	6	7	7	7	71
340	4	7	3	7	6	5	6	4	2	4	1	4	53
341	4	4	3	4	3	3	3	3	3	2	2	4	38
342	6	7	4	4	4	4	4	1	1	5	1	1	42
343	7	7	7	7	7	7	7	7	5	4	4	7	76
344	7	7	5	6	6	6	6	5	6	5	5	7	71
345	4	2	1	3	3	2	2	2	2	2	2	2	27
346	5	3	6	5	4	5	3	2	2	3	1	5	44
347	7	7	7	7	7	7	7	7	7	7	7	7	84
348	5	4	5	5	4	3	2	3	5	3	2	3	44
349	7	6	1	7	3	2	4	3	7	7	7	7	61
350	7	3	2	2	4	4	4	4	2	2	2	1	37
351	4	4	4	4	4	4	4	4	4	4	4	4	48
352	7	6	6	7	6	4	6	6	7	7	7	7	76
353	7	6	4	4	5	4	6	4	4	4	4	2	54
354	6	6	2	4	4	5	6	6	4	4	5	4	56
355	4	4	4	4	4	4	4	4	4	4	4	4	48
356	7	7	6	7	7	7	7	7	7	7	7	7	83
357	7	5	2	6	7	7	7	7	7	7	7	7	76
358	7	7	4	7	3	3	3	4	4	7	7	7	63
359	6	6	6	6	6	6	6	6	6	6	6	6	72
360	5	7	7	7	7	6	7	7	7	7	7	7	81
361	6	6	1	3	7	6	7	7	7	6	5	6	67
362	6	5	4	5	7	6	7	5	7	7	7	7	73
363	6	6	6	7	6	6	7	7	7	7	7	7	79
364	7	6	7	5	5	6	6	3	5	5	5	5	65
365	5	4	3	5	6	4	6	5	5	6	5	5	59

366	4	5	2	4	3	2	5	4	3	3	4	4	43
367	7	6	4	6	4	4	5	7	4	5	7	5	64
368	7	7	1	3	7	4	7	7	7	7	7	7	71
369	4	4	2	2	2	2	2	2	7	7	7	7	48
370	6	6	4	5	6	4	7	7	7	7	7	7	73
371	7	6	7	7	5	1	4	5	6	6	6	6	66
372	7	4	4	7	4	4	4	4	7	7	7	7	66
373	7	7	7	7	6	6	6	6	7	7	7	7	80
374	7	7	7	7	7	2	7	5	7	7	7	7	77
375	7	7	4	5	5	6	7	7	4	4	4	4	64
376	5	5	1	3	5	4	7	6	5	6	2	6	55
377	6	7	4	6	4	4	4	4	7	4	6	7	63
378	7	7	6	6	6	6	7	7	7	7	6	7	79
379	4	4	2	3	4	6	7	7	7	7	7	7	65
380	4	4	4	4	2	1	5	3	7	7	7	7	55
381	7	4	7	7	7	4	4	4	7	7	7	7	72
382	4	5	3	4	5	5	4	4	5	5	6	5	55
383	4	4	4	4	5	5	6	6	6	5	5	5	59
384	7	6	6	6	6	5	7	7	1	4	4	2	61
385	7	7	4	4	4	4	4	4	4	4	4	4	54
386	7	7	4	6	4	4	4	5	7	7	7	7	69
387	7	5	7	7	4	4	5	4	5	5	3	4	60
388	7	6	7	7	6	5	7	6	7	7	7	7	79
389	7	7	7	7	6	6	7	1	6	6	7	7	74
390	4	4	3	4	4	4	4	4	6	6	6	6	55
391	6	6	4	4	6	6	5	5	6	7	6	6	67
392	7	7	7	7	6	6	7	5	5	7	4	4	72
393	7	7	7	7	7	7	7	7	7	7	7	7	84
394	7	7	5	6	4	4	5	3	5	6	7	7	66
395	5	5	4	6	4	3	4	4	5	6	4	6	56
396	4	4	2	4	5	5	7	7	7	5	7	7	64
397	6	6	5	6	5	5	6	7	7	6	6	7	72
398	5	4	1	2	7	6	7	7	7	7	7	7	67
399	7	7	4	7	7	7	7	7	7	7	7	7	81
400	7	4	2	6	4	5	4	3	2	2	2	2	43
401	7	7	6	7	4	4	4	1	7	2	7	7	63
402	7	4	7	7	4	5	4	4	4	5	5	5	61
403	7	5	5	7	6	5	6	6	5	5	5	5	67
404	7	7	1	5	3	1	1	5	1	1	7	1	40
405	4	4	4	3	6	4	7	4	5	4	4	4	53
406	4	5	2	4	6	5	5	5	6	6	6	5	59

448	7	6	5	7	7	6	7	7	7	7	7	7	80
449	7	7	6	7	7	7	7	7	7	7	7	6	82
450	6	6	6	6	5	6	6	5	5	6	5	5	67
451	7	5	1	1	7	5	7	4	4	1	5	4	51
452	7	6	1	7	7	4	7	7	7	6	1	2	62
453	3	2	3	3	5	6	6	6	6	6	6	6	58
454	6	4	3	4	4	3	4	2	3	3	2	2	40
455	6	6	4	5	4	4	6	3	6	4	6	4	58
456	7	6	5	7	4	4	3	3	4	3	3	2	51
457	7	7	6	7	6	6	6	6	4	4	4	4	67
458	7	6	3	7	6	4	7	4	7	7	7	7	72
459	7	7	7	7	4	5	7	7	3	7	4	4	69
460	3	3	1	3	4	2	4	2	6	5	5	4	42
461	3	1	1	1	4	4	7	4	1	1	1	4	32
462	7	7	5	7	7	7	7	5	6	7	7	7	79
463	7	7	4	7	6	5	4	4	7	7	7	7	72
464	5	6	3	7	5	2	7	5	7	7	7	7	68
465	4	4	7	7	7	7	7	7	7	7	7	7	78
466	4	4	7	7	7	7	7	7	7	7	7	7	78
467	6	7	4	7	5	4	6	3	3	3	2	6	56
468	6	6	6	7	5	4	6	5	4	6	6	6	67
469	4	3	1	6	7	7	7	7	6	7	6	3	64
470	4	4	1	1	1	1	1	1	7	7	4	4	36
471	6	6	6	6	4	4	4	4	7	7	7	7	68
472	6	7	4	3	3	4	7	1	7	3	3	3	51
473	6	6	5	6	7	6	6	6	6	5	5	4	68
474	5	5	6	6	6	6	6	6	6	7	6	6	71
475	7	3	1	1	7	7	7	7	7	7	7	7	68
476	3	5	4	4	5	5	5	5	4	5	5	5	55
477	7	7	6	7	5	5	4	5	6	4	2	6	64
478	6	6	5	5	7	6	6	5	6	6	5	5	68
479	4	7	7	7	4	5	4	4	6	7	7	7	69
480	7	4	4	4	4	4	5	2	6	6	6	6	58
481	5	5	3	5	5	4	3	3	3	3	3	3	45
482	7	4	1	7	7	7	7	7	7	7	7	7	75
483	7	6	1	4	7	4	7	7	1	7	7	6	64
484	7	7	6	6	5	7	6	5	7	4	6	5	71
485	6	6	6	6	6	6	4	4	5	5	5	5	64
486	7	7	7	7	4	4	7	6	4	6	4	4	67
487	7	7	3	7	1	1	1	3	7	7	7	7	58
488	7	7	4	7	7	5	4	4	7	7	7	3	69

489	7	6	6	6	5	5	4	4	5	4	4	4	60
490	7	7	7	7	1	1	1	1	7	7	7	7	60
491	7	7	5	7	3	5	5	5	6	5	4	6	65
492	7	7	4	7	7	4	4	5	5	7	7	7	71
493	7	7	6	5	2	3	2	1	7	6	6	7	59
494	4	3	1	1	4	2	4	1	7	7	7	7	48
495	6	1	1	1	1	1	1	1	4	4	1	1	23
496	6	4	3	5	6	5	7	6	6	7	5	5	65
497	6	7	7	7	1	2	6	6	7	7	7	7	70
498	1	1	1	1	1	1	3	1	4	1	1	1	17
499	6	4	4	4	4	4	4	4	7	6	7	7	61
500	7	7	4	7	7	7	7	7	7	7	7	7	81
501	4	4	4	4	4	4	4	4	7	4	4	4	51
502	5	5	2	4	6	5	6	5	7	7	7	7	66
503	7	4	4	7	4	4	4	4	4	4	4	4	54
504	4	4	4	4	7	5	3	3	4	4	7	7	56
505	7	4	4	4	7	6	7	7	3	6	2	4	61
506	7	4	7	7	7	7	7	7	7	7	7	7	81
507	7	7	7	7	6	6	6	6	4	4	4	4	68
508	6	6	4	4	4	4	5	3	4	4	3	4	51
509	7	7	7	7	6	5	6	4	6	6	7	7	75
510	7	7	5	7	7	7	7	5	7	7	7	7	80
511	6	4	5	7	6	4	6	6	6	7	7	7	71
512	7	6	4	6	4	4	4	4	4	4	4	6	57
513	7	6	6	6	5	4	5	4	4	4	4	4	59
514	4	6	2	6	4	4	4	3	4	4	4	4	49
515	4	2	2	2	4	3	4	3	2	2	4	2	34
516	7	7	7	7	7	5	7	7	7	7	7	7	82
517	4	4	4	4	4	4	4	6	7	7	7	7	62
518	7	7	5	6	5	4	6	3	7	5	7	7	69
519	7	7	6	3	4	4	4	6	5	4	3	5	58
520	7	6	4	6	5	4	3	3	4	4	5	4	55
521	7	6	4	6	3	5	1	2	5	5	6	4	54
522	7	6	4	4	6	5	6	4	6	6	5	6	65
523	7	6	4	4	6	2	5	4	6	4	6	4	58
524	1	6	4	6	4	3	5	4	7	7	7	7	61
525	4	7	4	4	5	5	6	5	4	7	6	7	64
526	7	6	4	6	4	4	3	5	3	3	3	4	52
527	3	5	5	4	4	5	6	3	4	5	4	4	52
528	7	6	7	7	7	6	6	6	7	7	7	5	78
529	7	6	4	6	5	6	4	6	6	6	5	6	67

530	6	6	5	3	4	5	6	7	7	7	7	7	70
531	7	7	3	4	4	4	6	5	4	3	5	5	57
532	7	7	5	5	6	7	6	6	7	5	7	7	75
533	5	5	2	6	6	7	6	7	7	6	4	4	65
534	6	3	1	4	3	5	7	7	7	7	7	7	64
535	6	7	4	5	7	7	7	7	7	7	6	6	76
536	7	6	6	6	6	5	4	4	7	7	7	7	72
537	4	2	1	4	7	7	7	4	6	4	7	7	60
538	6	4	2	2	6	6	7	2	1	1	1	7	45
539	4	5	2	4	4	4	5	5	6	6	6	6	57
540	7	6	3	5	6	6	7	7	4	4	4	4	63
541	7	7	2	7	1	3	7	4	7	5	3	1	54
542	7	5	5	5	5	5	5	5	5	7	7	7	68
543	3	3	2	3	4	5	7	7	6	6	5	3	54
544	2	4	7	7	4	4	5	4	7	7	7	7	65
545	4	4	1	3	4	5	4	6	4	2	3	3	43
546	7	7	4	6	4	4	3	3	6	4	3	3	54
547	6	7	7	7	6	6	6	6	7	7	7	7	79
548	7	6	7	7	7	6	7	7	1	1	1	1	58
549	7	7	5	6	5	6	5	6	6	5	5	3	66
550	6	4	2	7	4	4	5	5	2	2	2	4	47
551	5	3	3	4	2	1	3	3	1	3	6	6	40
552	4	4	3	4	4	4	4	4	6	6	6	6	55
553	6	6	4	6	4	4	6	4	5	6	4	4	59
554	6	6	7	6	6	7	5	7	6	7	7	6	76
555	6	6	6	6	5	4	5	4	4	4	4	4	58
556	7	6	5	5	6	5	6	7	7	6	5	4	69
557	6	4	3	6	4	5	5	5	6	6	7	5	62
558	4	2	4	5	5	4	6	6	5	7	6	6	60
559	7	4	4	6	6	5	7	6	6	6	7	7	71
560	6	3	3	6	3	2	4	5	6	4	2	5	49
561	7	4	3	4	6	5	7	7	6	6	6	6	67
562	6	4	7	4	6	5	6	4	7	4	7	7	67
563	7	7	7	5	6	5	6	7	7	7	7	7	78
564	6	6	7	7	4	7	6	7	6	7	6	6	75
565	6	3	1	4	5	3	5	7	1	6	1	6	48
566	6	6	6	7	7	5	5	3	4	6	6	7	68
567	7	7	5	6	5	6	5	6	5	4	3	4	63
568	7	4	4	6	6	5	7	6	6	6	7	7	71
569	6	4	3	6	4	5	5	5	6	6	7	5	62
570	7	4	3	4	6	5	7	7	6	6	6	6	67

571	4	4	3	4	4	4	4	3	6	6	4	4	50
572	6	6	6	6	5	4	5	4	4	4	4	4	58
573	7	1	6	5	4	4	4	2	4	6	6	5	54
574	6	4	7	7	7	7	7	7	7	7	7	7	80
575	1	2	2	7	6	6	7	5	6	4	5	7	58
576	6	3	1	4	3	5	7	7	7	7	7	7	64
577	6	6	5	7	6	7	7	7	7	7	7	7	79
578	6	6	4	6	7	5	7	7	6	4	6	6	70
579	6	3	1	4	5	3	5	7	1	6	1	6	48
580	6	5	3	7	7	7	7	7	7	7	7	7	77
581	7	7	4	7	6	6	6	6	7	6	7	7	76
582	7	7	7	7	6	6	6	6	6	6	6	6	76
583	3	3	2	3	4	4	4	4	4	4	4	4	43
584	7	6	7	7	7	6	6	6	7	7	7	5	78
585	4	6	3	4	6	6	6	6	6	6	6	6	65
586	4	4	1	3	4	5	4	5	6	4	2	3	45
587	7	7	7	7	7	5	5	5	3	7	7	7	74
588	6	6	5	7	4	4	5	5	7	7	7	7	70
589	6	3	1	2	6	5	5	6	3	1	2	1	41
590	7	7	6	7	4	3	4	4	4	4	1	4	55
591	7	7	5	6	4	4	4	4	6	6	7	5	65
592	7	5	4	5	4	3	4	2	6	6	5	5	56
593	7	6	6	6	4	4	3	3	4	4	3	4	54
594	7	7	7	7	7	7	7	7	7	7	7	7	84
595	7	6	6	6	6	6	6	6	6	6	6	6	73
596	7	5	5	5	6	5	5	3	6	7	3	4	61
597	7	6	4	6	4	4	4	2	1	2	1	4	45
598	7	7	7	7	7	7	7	7	7	7	7	7	84
599	4	4	4	4	4	4	4	4	4	4	4	4	48
600	7	7	7	7	7	7	7	7	1	1	4	1	63
601	7	7	6	7	7	7	7	7	7	7	7	7	83
602	7	6	5	7	6	7	7	7	7	7	5	6	77
603	3	3	2	3	2	2	2	2	2	1	2	2	26
604	6	6	4	4	6	4	4	4	4	4	4	4	54
605	7	6	5	6	4	4	3	4	6	4	6	6	61
606	4	1	1	2	5	5	7	7	1	4	4	1	42
607	7	7	7	7	6	6	6	6	7	7	7	7	80
608	6	4	1	3	5	5	3	1	2	1	1	1	33
609	7	6	1	7	4	3	4	3	7	7	7	7	63
610	7	7	7	7	7	4	4	4	4	3	4	7	65
611	7	7	4	6	6	4	7	2	2	1	1	1	48

653	6	7	6	5	5	6	5	6	5	6	5	6	68
654	7	7	5	7	4	4	4	4	4	3	4	4	57
655	7	7	7	6	6	6	7	7	6	7	5	2	73
656	7	7	1	4	4	3	2	2	1	2	2	1	36
657	5	6	5	5	5	5	5	6	4	4	4	4	58
658	7	7	7	7	6	6	7	7	7	6	6	6	79
659	5	5	3	5	5	3	4	3	7	7	7	7	61
660	7	6	7	7	7	7	7	7	7	7	7	7	83
661	7	7	7	7	7	7	7	7	7	7	7	7	84
662	4	4	4	4	4	4	4	4	4	4	4	4	48
663	7	7	7	7	7	7	7	7	7	7	7	7	84
664	7	7	6	6	6	1	2	3	3	3	4	4	52
665	4	4	4	4	4	4	4	4	3	5	4	3	47
666	1	4	6	3	2	7	4	3	2	5	5	5	47
667	7	7	7	7	7	7	7	6	6	5	5	5	76
668	7	7	7	7	7	7	6	6	6	6	6	5	77
669	7	6	7	7	7	6	7	4	5	5	5	5	71
670	6	7	7	7	7	7	6	6	6	6	6	6	77
671	7	7	7	7	7	7	7	6	6	5	5	7	78
672	4	7	7	7	6	6	6	6	6	5	6	5	71
673	6	7	5	7	7	4	5	5	6	5	6	6	69
674	7	7	5	5	5	6	6	6	6	6	4	5	68
675	6	6	4	4	5	5	5	5	4	5	5	5	59
676	4	4	3	5	4	4	4	4	4	4	4	4	48
677	7	6	5	5	6	4	6	6	5	6	5	5	66
678	7	7	7	7	6	5	6	6	7	7	7	7	79
679	7	7	7	7	7	7	4	4	7	7	7	7	78
680	6	6	5	5	6	4	6	6	6	7	7	6	70
681	6	6	4	6	6	4	4	4	7	7	7	7	68
682	6	4	4	4	4	4	4	4	4	4	4	4	50
683	7	7	7	7	7	7	7	7	7	7	7	7	84
684	7	5	5	5	5	5	5	5	5	5	5	5	62
685	7	7	6	7	6	6	6	6	7	7	7	7	79
686	7	7	7	7	4	4	4	4	1	1	1	1	48
687	7	4	7	7	4	4	7	7	4	4	4	4	63
688	7	4	1	4	6	5	7	5	7	7	7	7	67
689	5	5	6	4	6	5	5	6	7	6	7	6	68
690	7	7	6	6	6	6	6	6	7	7	7	7	78
691	6	6	7	7	6	6	6	6	6	6	7	7	76
692	7	7	7	7	7	7	7	7	7	7	7	7	84
693	6	6	6	4	6	6	6	6	4	4	4	4	62

694	7	7	7	7	4	2	2	2	7	7	7	7	66
695	2	1	1	1	1	1	1	1	1	1	1	1	13
696	7	5	4	7	6	6	6	6	6	6	6	6	71
697	6	7	6	4	6	4	7	6	7	6	7	7	73
698	6	7	6	5	6	6	6	5	6	6	5	4	68
699	6	4	4	6	4	4	2	4	4	2	4	4	48
700	6	6	5	6	7	6	7	6	6	5	5	7	72
701	7	6	4	6	6	6	7	6	4	4	4	4	64
702	7	7	7	7	7	7	7	7	6	7	6	7	82
703	4	4	4	4	4	4	4	4	4	4	4	4	48
704	4	1	4	4	6	5	4	3	7	7	7	7	59
705	7	4	4	4	4	4	4	4	4	4	4	4	51
706	7	7	7	7	6	5	6	7	5	7	7	7	78
707	4	4	4	4	4	4	4	4	4	4	4	4	48
708	4	4	4	4	4	4	4	4	4	4	4	4	48
709	6	3	1	2	4	3	6	7	7	7	7	7	60
710	6	6	7	6	1	1	2	1	7	7	7	7	58
711	3	4	2	3	5	5	5	5	7	7	7	7	60
712	4	4	4	4	4	4	4	4	4	4	4	4	48
713	4	4	4	4	4	4	4	3	7	7	7	7	59
714	7	4	4	4	4	4	4	4	4	4	4	4	51
715	7	6	5	6	6	6	6	6	6	6	6	6	72
716	6	5	6	5	6	6	6	6	6	5	6	6	69
717	5	1	1	7	7	7	7	7	7	7	7	7	70
718	4	2	2	4	2	1	1	1	7	7	7	7	45
719	7	7	7	7	7	7	7	4	4	4	4	4	69
720	7	7	7	7	4	2	1	4	1	1	1	1	43
721	4	2	4	4	4	4	4	4	4	4	4	4	46
722	4	2	1	3	2	2	1	1	7	7	7	7	44
723	6	7	5	6	4	5	6	5	7	5	7	7	70
724	7	6	7	7	4	5	6	7	5	6	7	6	73
725	5	4	4	4	6	5	6	7	7	7	7	7	69
726	5	5	1	5	5	5	5	5	5	1	5	5	52
727	4	4	4	4	4	4	4	4	4	4	4	4	48
728	6	5	4	4	5	4	4	4	4	4	5	4	53
729	5	6	3	5	5	4	7	7	5	6	7	4	64
730	7	4	4	4	5	3	4	4	6	6	6	6	59
731	6	5	6	5	6	6	6	6	6	1	1	1	55
732	7	7	7	5	5	4	5	5	6	7	6	7	71
733	4	4	4	4	4	4	4	4	4	4	4	4	48
734	4	4	4	4	7	7	7	7	7	4	4	4	63

735	7	7	7	7	6	7	7	7	7	7	7	7	83
736	7	5	2	2	3	3	4	6	2	3	3	1	41
737	7	7	7	7	7	5	5	5	5	4	4	4	67
738	6	1	1	1	7	7	7	7	7	7	7	7	65
739	6	4	1	4	6	2	4	4	4	3	2	3	43
740	6	6	3	7	6	6	6	2	6	4	4	4	60
741	4	4	1	7	7	1	7	4	1	1	7	7	51
742	7	3	1	2	2	1	7	3	7	1	6	3	43
743	7	7	7	7	7	5	5	5	1	1	1	1	54
744	7	7	7	7	5	4	6	7	7	7	7	7	78
745	6	5	4	4	5	5	4	4	4	3	2	6	52
746	6	6	4	7	6	5	6	5	5	5	5	5	65
747	7	7	7	7	7	7	4	7	7	7	7	7	81
748	7	4	4	7	4	4	4	5	4	4	4	4	55
749	7	7	7	6	5	5	5	5	7	7	7	7	75
750	6	6	3	5	5	5	6	5	7	7	6	6	67
751	7	1	7	7	7	7	7	7	7	7	7	7	78
752	6	4	3	3	6	6	6	3	7	7	7	6	64
753	4	4	4	4	5	4	6	4	4	4	4	4	51
754	7	7	7	7	6	6	7	6	1	4	1	1	60
755	7	7	5	7	7	7	7	4	7	4	7	7	76
756	6	6	6	6	4	4	6	6	6	6	6	6	68
757	7	2	4	4	6	4	7	6	5	4	5	5	59
758	4	5	1	4	6	4	7	7	4	6	4	7	59
759	6	4	4	5	4	4	5	4	4	4	3	3	50
760	5	6	1	5	6	4	6	6	5	6	5	5	60
761	6	6	4	4	2	4	4	5	2	4	1	1	43
762	6	6	5	7	5	4	4	5	7	5	7	7	68
763	4	7	4	5	5	5	6	5	5	6	6	5	63
764	7	2	6	4	6	4	6	6	7	7	7	7	69
765	7	5	4	5	4	4	7	5	7	5	5	7	65
766	7	2	6	6	6	4	6	7	7	7	7	7	72
767	7	5	3	4	5	4	6	6	2	2	5	4	53
768	4	4	2	5	6	4	5	6	2	5	5	5	53
769	7	6	4	5	7	2	6	4	6	4	4	7	62
770	6	5	1	4	2	1	4	2	7	6	7	4	49
771	7	6	6	6	6	6	4	4	6	4	4	6	65
772	4	4	3	4	7	5	7	7	7	7	7	7	69
773	4	1	1	4	3	1	2	2	1	1	1	1	22
774	7	4	4	6	2	1	1	1	6	6	4	5	47
775	5	4	4	3	4	4	4	4	4	6	6	6	54

Output SPSS

A. Karakteristik Responden

Program Studi					
	Frequency	Percent	Valid Percent	Cumulative Percent	
	alih jenjang	9	1,2	1,2	1,2
	D3 Keperawatan	36	4,6	4,6	5,8
	D3 Kesehatan Lingkungan	10	1,3	1,3	7,1
	Profesi Ners	36	4,6	4,6	11,7
	S1 Akutansi	7	,9	,9	12,6
	S1 Farmasi	50	6,5	6,5	19,1
	S1 Hubungan Internasional	30	3,9	3,9	23,0
	S1 Hukum	63	8,1	8,1	31,1
	S1 Keperawatan	45	5,8	5,8	36,9
	S1 Kesehatan Lingkungan	18	2,3	2,3	39,2
Valid	S1 Kesehatan Masyarakat	73	9,4	9,4	48,6
	S1 Manajemen	145	18,7	18,7	67,4
	S1 Pendidikan Bahasa Inggris	17	2,2	2,2	69,5
	S1 Pendidikan Olahraga	17	2,2	2,2	71,7
	S1 Psikologi	74	9,5	9,5	81,3
	S1 Teknik Geologi	10	1,3	1,3	82,6
	S1 Teknik Informatika	74	9,5	9,5	92,1
	S1 Teknik Mesin	30	3,9	3,9	96,0
	S1 Teknik Sipil	27	3,5	3,5	99,5
	S2 Manajemen	4	,5	,5	100,0
	Total	775	100,0	100,0	

Tempat tinggal					
	Frequency	Percent	Valid Percent	Cumulative Percent	
	Keluarga	124	16,0	16,0	16,0
	Kontrak	71	9,2	9,2	25,2
Valid	Kos	301	38,8	38,8	64,0
	Orang Tua	279	36,0	36,0	100,0

Total	775	100,0	100,0
-------	-----	-------	-------

Pernah Berkuliah

	Frequency	Percent	Valid Percent	Cumulative Percent
Valid Tidak	721	93,0	93,0	93,0
Ya	54	7,0	7,0	100,0
Total	775	100,0	100,0	

Klasifikasi

	Frequency	Percent	Valid Percent	Cumulative Percent
Valid 17-25	764	98,6	98,6	98,6
26-35	6	,8	,8	99,4
36-45	5	,6	,6	100,0
Total	775	100,0	100,0	

B. Uji Normalitas Data

Descriptives

		Statistic	Std. Error	
Ansietas	Mean	49,50	,271	
	95% Confidence Interval for Mean	Lower Bound	48,97	
		Upper Bound	50,04	
	5% Trimmed Mean	49,59		
	Median	50,00		
	Variance	56,834		
	Std. Deviation	7,539		
	Minimum	20		
	Maximum	80		
	Range	60		
	Interquartile Range	9		
	Skewness	-,190	,088	
	Kurtosis	1,584	,175	

	Mean		61,91	,461
	95% Confidence Interval for Mean	Lower Bound	61,01	
		Upper Bound	62,82	
	5% Trimmed Mean		62,39	
	Median		63,00	
	Variance		164,867	
Dukungan_Sosial	Std. Deviation		12,840	
	Minimum		13	
	Maximum		84	
	Range		71	
	Interquartile Range		17	
	Skewness		-,543	,088
	Kurtosis		,357	,175

Percentiles

		Percentiles						
		5	10	25	50	75	90	95
Weighted	Ansietas	37,00	40,00	45,00	50,00	54,00	58,00	61,00
Average(Definition 1)	Dukungan_Sosial	41,00	45,00	54,00	63,00	71,00	78,00	82,00
Tukey's Hinges	Ansietas			45,00	50,00	54,00		
	Dukungan_Sosial			54,00	63,00	71,00		

Tests of Normality

	Kolmogorov-Smirnov ^a			Shapiro-Wilk		
	Statistic	df	Sig.	Statistic	df	Sig.
Ansietas	,067	775	,000	,982	775	,000
Dukungan_Sosial	,051	775	,000	,977	775	,000

a. Lilliefors Significance Correction

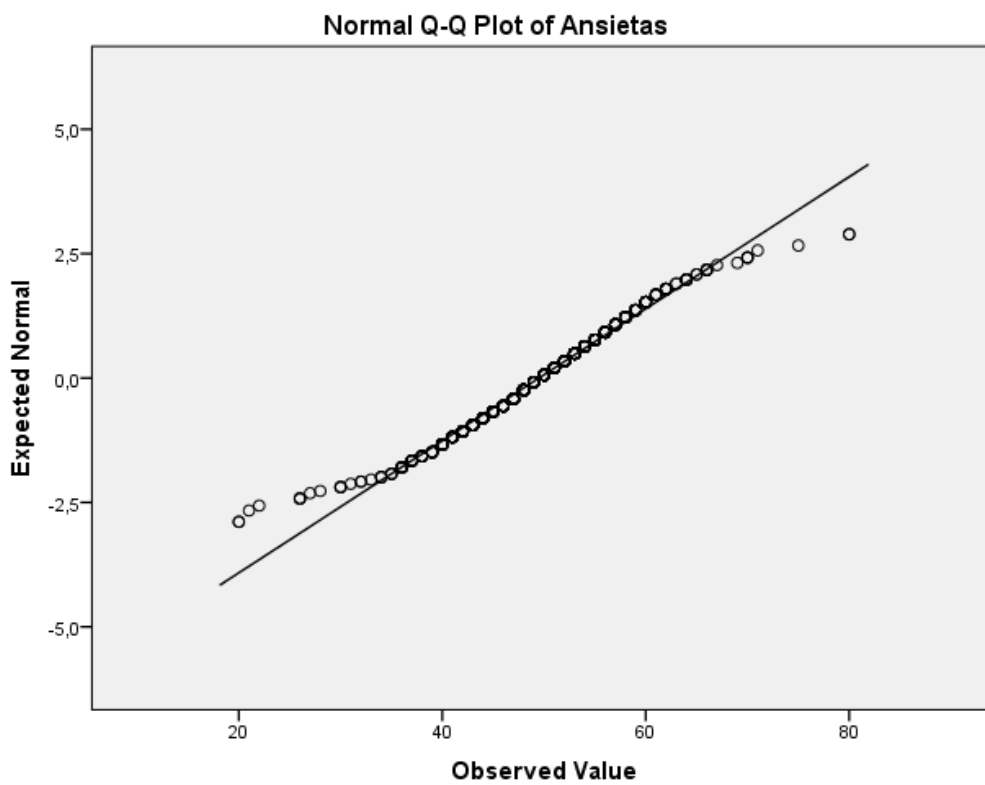
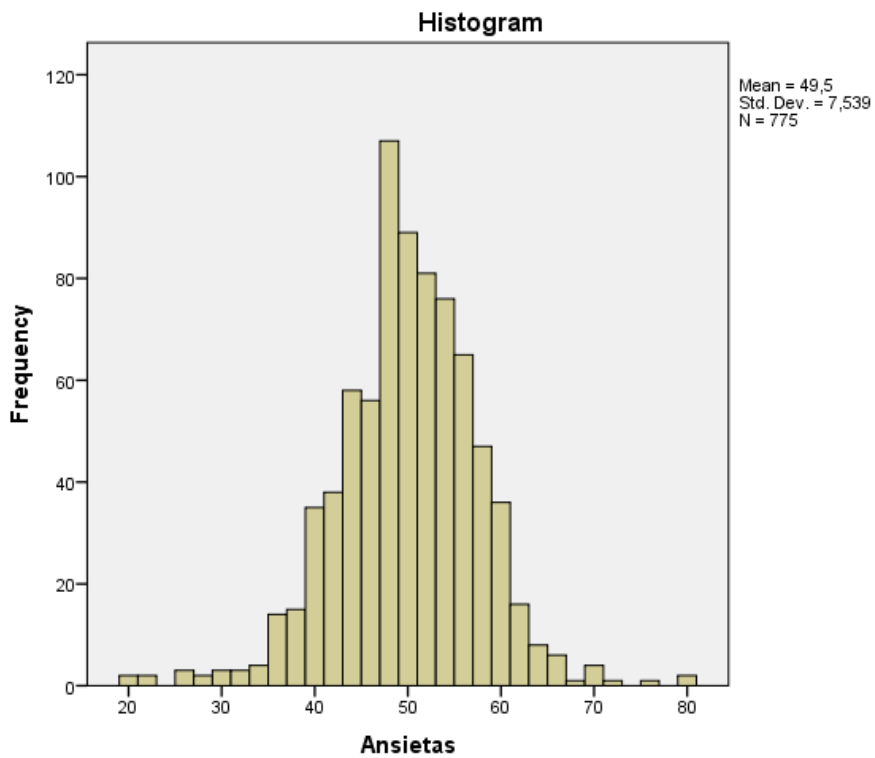

Detrended Normal Q-Q Plot of Ansietas

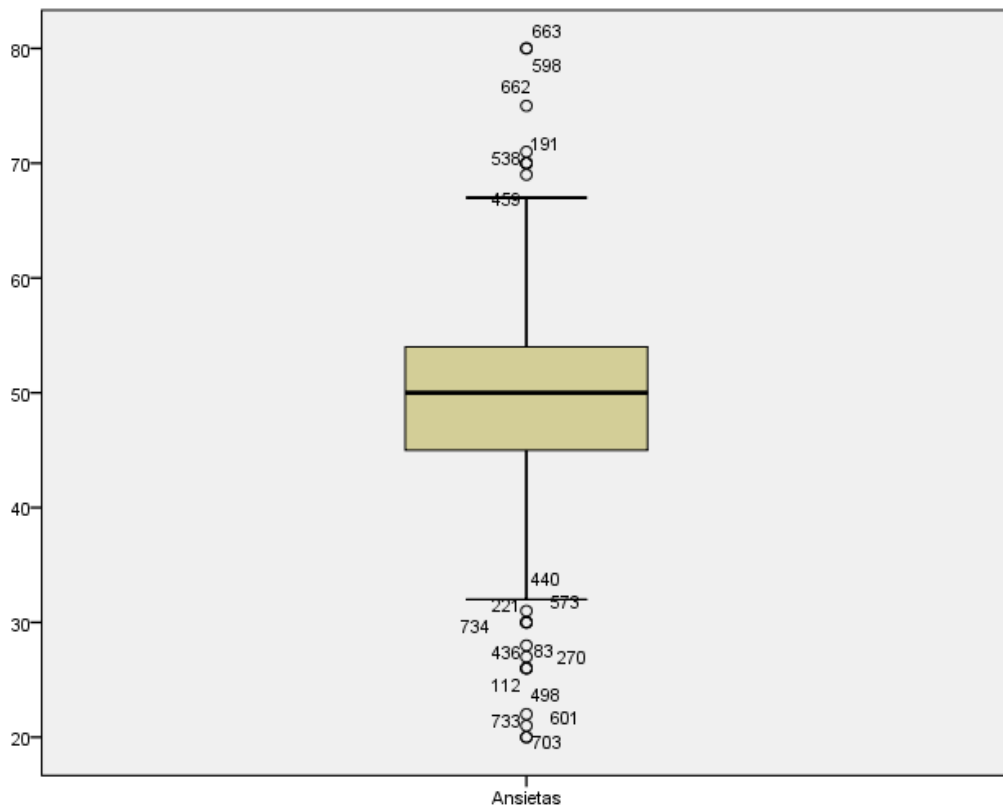
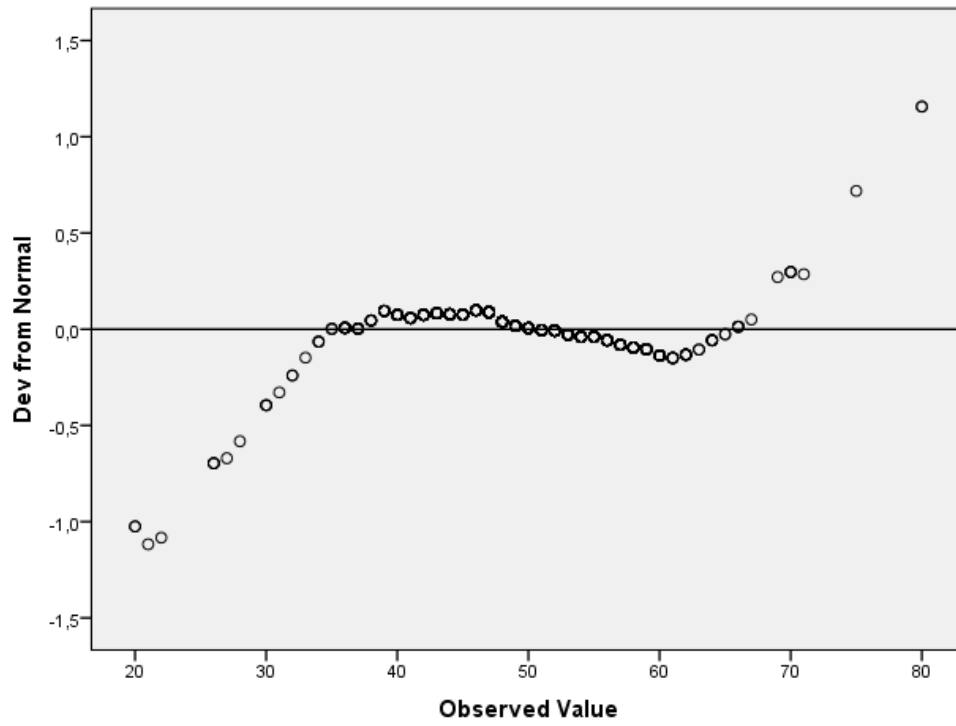

Dukungan_Sosial

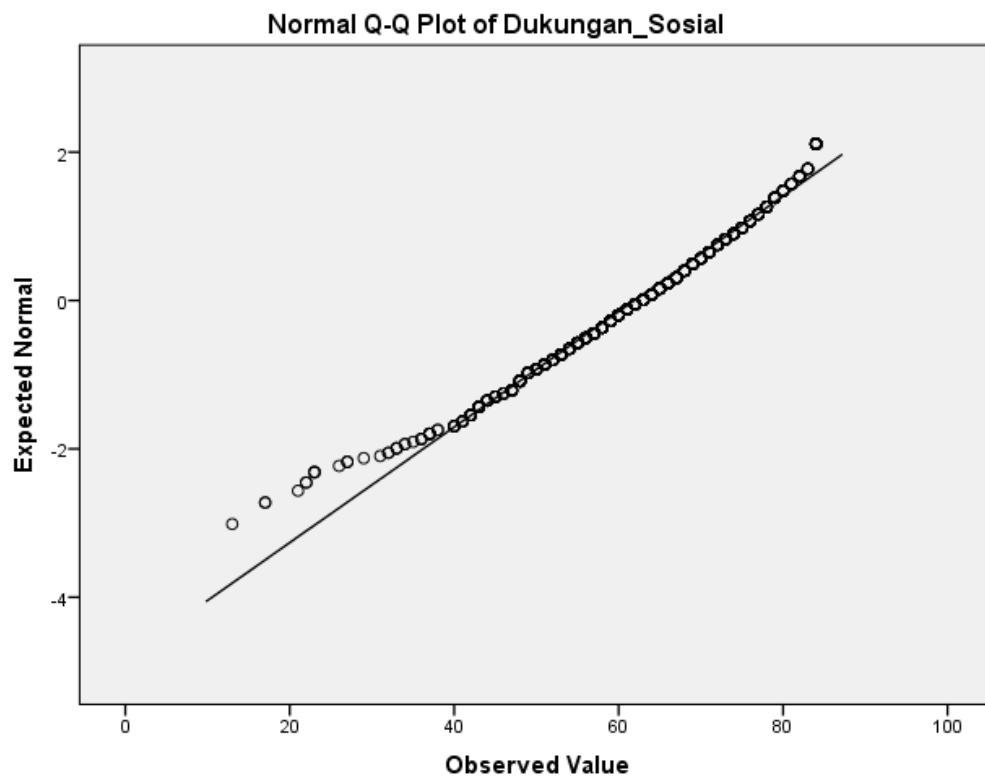
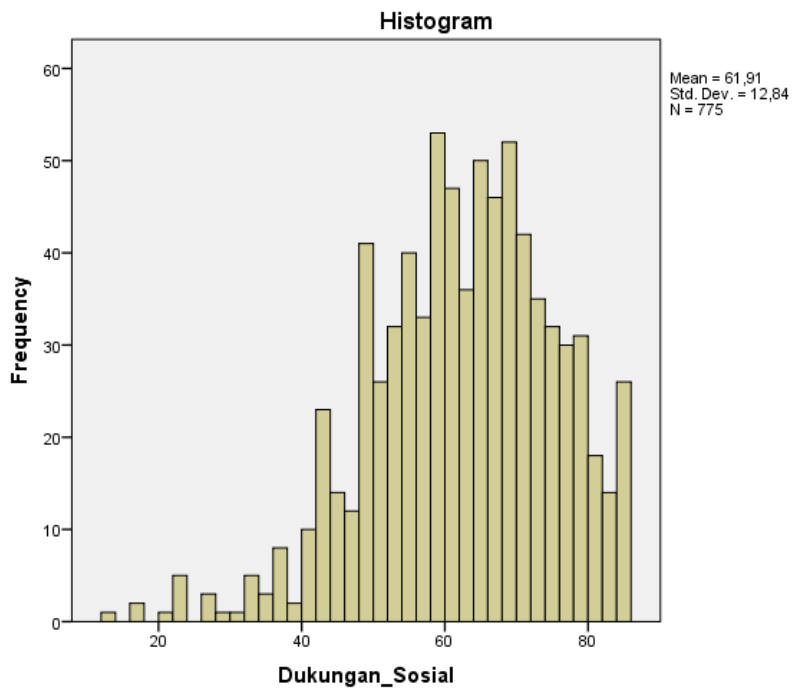

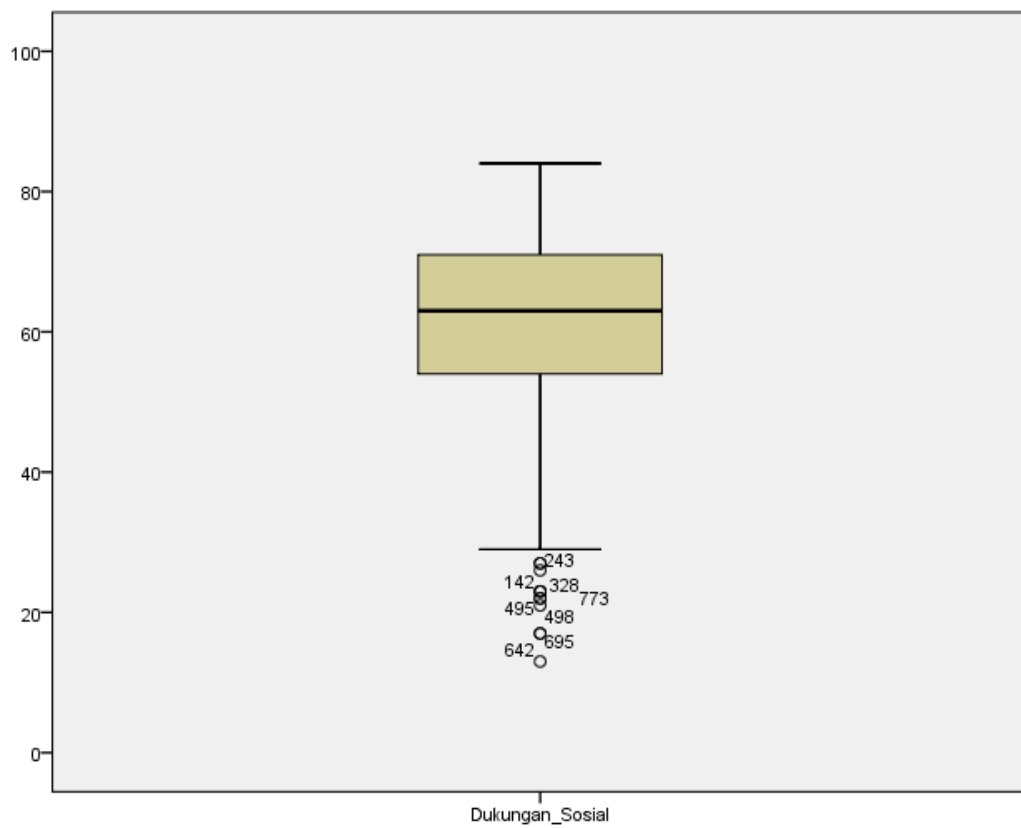
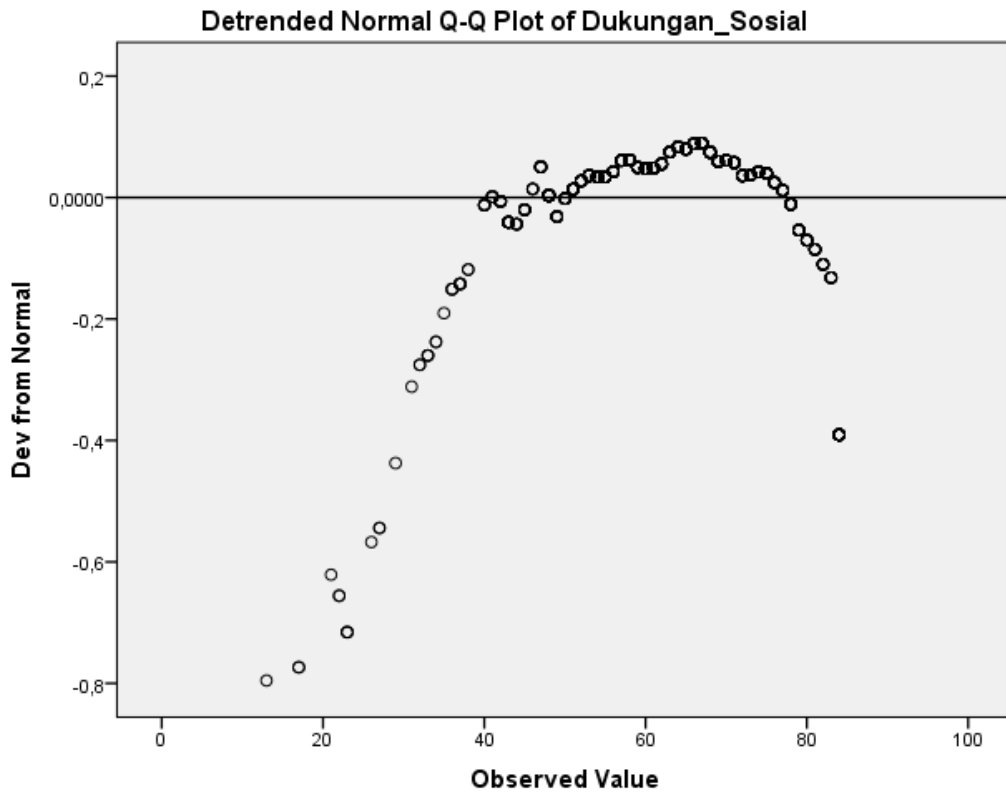

C. Analisis Nilai Univariat Ansietas dan Dukungan Sosial

		Statistics	
		Ansietas	Dukungan_Sosial
N	Valid	775	775
	Missing	0	0
Mean		49,50	61,91
Median		50,00	63,00
Mode		48	48
Std. Deviation		7,539	12,840
Minimum		20	13
Maximum		80	84

A. Uji Spearman

		Correlations	
		Ansietas	Dukungan_Sosial
Spearman's rho	Ansietas	Correlation Coefficient	1,000
		Sig. (2-tailed)	,133**
	Dukungan_Sosial	N	775
		Correlation Coefficient	,133**
		Sig. (2-tailed)	,000
		N	775

** . Correlation is significant at the 0.01 level (2-tailed).



UMKT
Program Studi
S1 Keperawatan

Fakultas Ilmu Keperawatan

Telp 0541-748511 Fax 0541-766832

Website <http://keperawatan.umkt.ac.id>

email : keperawatan@umkt.ac.id

بِسْمِ اللَّهِ الرَّحْمَنِ الرَّحِيمِ

Nomor : 394/FIK.2/A.7/B/2022
Lampiran : -
Perihal : Permohonan Ijin Penelitian

Kepada Yth.
Ketua LPPM
Universitas Muhammadiyah Kalimantan Timur
di-

T e m p a t

Assalamu 'alaikum Warahmatullahi Wabaraakatuh

Puji syukur kepada Allah Subhanahu wata 'ala serta sholawat dan salam kepada junjungan kita Nabi Muhammad Shallallahu'alaihi Wasallam yang senantiasa melimpahkan rahmat dan ridho-Nya semoga kita selalu sehat dan mendapat bimbingan dalam melakukan aktivitas sehari-hari. Aamiin.

Dalam rangka adanya penelitian kolaborasi dosen dan mahasiswa sebagai salah satu kegiatan Catur Dharma Perguruan Tinggi di Prodi Ilmu Keperawatan Fakultas Ilmu Keperawatan Universitas Muhammadiyah Kalimantan Timur, maka bersama ini kami mohon perkenan Bapak/ Ibu untuk mengizinkan tim peneliti kami melakukan penelitian dan di Institusi yang Bapak/ Ibu pimpin dengan judul penelitian : "Analisis Faktor-faktor yang berhubungan dengan Ansietas terhadap Pembelajaran Mahasiswa di Universitas Muhammadiyah Kalimantan Timur".

Adapun daftar nama tim peneliti, sebagai berikut:

1. Ketua : Ns. Dwi Rahmah Fitriani, M.Kep (NIDN. 1119097601)
2. Anggota:
 - a. Siti Citra Camila (NIM. 1911102411028)
 - b. Hardina Saputri (NIM. 1911102411070)
 - c. Riki Wahyudi (NIM. 1911102411034)

Demikian permohonan dari kami, atas perhatian dan kerjasamanya kami ucapkan terima kasih.

Wassalamu 'alaikum Warahmatullahi Wabaraakatuh

Samarinda, 26 Rabiul Akhir 1444 H

21 November 2022 M

Ketua Prodi Ilmu Keperawatan, 

Ns. Siti Khoiroh Muflihatin, S. Pd., M.Kep
NIDN. 1115017703



- Tembusan Yth:
1. Ketua Prodi Profesi Ners
 2. Ketua Prodi S1 Keperawatan
 3. Ketua Prodi DIII Keperawatan



Universitas Mahadewa
Kalimantan Timur
Fakultas Keperawatan (Bontomatene)

UMKT

Program Studi
S1 Keperawatan

Fakultas Ilmu Keperawatan

Telp. 0541-748511 Fax.0541-766832

Website <http://keperawatan.umkt.ac.id>

email : keperawatan@umkt.ac.id



4. Ketua Prodi S1 Kesehatan Lingkungan
5. Ketua Prodi DIII Kesehatan Lingkungan
6. Ketua Prodi S1 Farmasi
7. Ketua Prodi S1 Hubungan Internasional
8. Ketua Prodi S1 Hukum
9. Ketua Prodi S1 Kesehatan Masyarakat
10. Ketua Prodi S1 Manajemen
11. Ketua Prodi S2 Manajemen
12. Ketua Prodi S1 Pendidikan Bahasa Inggris
13. Ketua Prodi S1 Pendidikan Olahraga
14. Ketua Prodi S1 Psikologi
15. Ketua Prodi S1 Teknik Geologi
16. Ketua Prodi S1 Teknik Informatika
17. Ketua Prodi S1 Teknik Mesin
18. Ketua Prodi S1 Teknik Sipil
19. Ketua Prodi S1 Akuntansi
20. Arsip
21. Ybs



L P P M
Lembaga Penelitian dan
Pengabdian pada Masyarakat

Telp. 0541-748511 Fax 0541-766832

Website <http://lppm.umkt.ac.id>

email: lppm@umkt.ac.id



Nomor : 965/LPPM/A.3/2022
Lampiran : -
Perihal : Surat Ijin Penelitian

Kepada
Yth. Ketua Prodi S1 Keperawatan
di-

Tempat

Assalamu 'alaikum warrahmatullahi wabarrakatus.

Puji Syukur senantiasa kita panjatkan kehadirat Allah SWT, atas berkah dan karuniaNya sehingga kita masih diberikan kesehatan dan kesempatan untuk beribadah dan berkarya. Amin.

Menindaklanjuti surat Permohonan ijin penelitian No.394/FIK.2/A.7/B/2022 bahwa kami memberikan ijin kepada :

1. Siti Citra Camila	1911102411028
2. Hardiana Saputri	1911102411070
3. Riki Wahyudi	1911102411034

Untuk Melakukan Penelitian dalam rangka penyusunan tugas akhir Skripsi Mahasiswa Program Studi S1 Keperawatan, Universitas Muhammadiyah Kalimantan Timur. Terhitung mulai tanggal 25 November – 25 Desember 2022.

Demikian surat ini dibuat, untuk dipergunakan sebagaimana mestinya.

Nevron Minallah Wa Fathun Qorib Wassalamu 'alaikum
warrahmatullahi wabarrakatus

Samarinda, 25 November 2022 M
30 Rabiul Akhir 1444 H



Ketua LPPM,

Paula Mariana Kustiawan, Ph.D.
NIDN. 1114038901

Dokumentasi



LEMBAR KONSULTASI (bimbingan)

Nama Mahasiswa : Siti Citra Camila
 NIM : 1911102411028
 Judul Penelitian : Perkembangan Dukungan Sosial Dengan Ansietas Pada Mahasiswa Di Universitas Muhammadiyah Kalimantan Timur
 Nama Pembimbing : Ns. Dwi Rahmah Fitriani, M.Kep

NO	TANGGAL	KONSULTASI	HASIL KONSULTASI	PARAF
1	18 Juli 2022	Konsultasi mengenai awal skripsi	Melanjutkan ambil skripsi dan mulai melanjutkan proposal dan merencanakan jadwal ujian	h
2	19 Agustus 2022	Konsultasi mengenai Populasi	Populasi tetap dilanjutkan dengan melakukan mengirimkan surat ke BAA	h
3	21 Agustus 2022	Konsultasi proposal	Revisi mengenai judul yang terbalik dan mengenai kuesioner yang akan dipakai	h
4	23 Agustus 2022	Konsultasi Kuesioner	Kuesioner yang akan dipakai diganti menjadi STAI	h
5	25 Agustus 2022	Konsultasi Proposal	Revisi judul menghilangkan mahasiswa baru, latar belakang yang data nya terlalu lama, kerangka teori dan kerangka konsep direvisi, definisi operasional, dan kuesioner	h

6	28 Agustus 2022	Konsultasi kuesioner Ansietas dan dukungan sosial	Mencari jurnal bahasa Inggris dan bahasa Indonesia yang ada kuesioner didalamnya	h
7	30 Agustus 2022	Konsultasi rumus populasi dan kuesioner	Populasi masih dicari untuk jumlah besar dan kuesioner STAI diubah menjadi SAI	h
8	6 September 2022	Konsultasi proposal	Revisi bab 1 : kalimat di manfaat diubah Bab 2 : bagian kuesioner SAI ditambahkan Bab 3 : Definisi operasional, rumus slovin menggunakan 3%, tambahkan uji normalitas.	h
9	26 September 2022	Revisi hasil Seminar proposal	Mengenai DO dan analisa data serta Hasil revisi disesuaikan dengan revisi dosen penguji	h
10.	8 oktober 2022	Konsul mengenai prodi di paser	Tidak menggunakan mahasiswa prodi yang ada di paser	h
11.	17 Oktober 2022	Konsul mengenai kode etik dan penyebaran kuesioner	Penyebaran dilakukan secara offline dengan memberikan hadiah dari peneliti	h
13	21 November 2022	Data Tabulasi	Hasil Data Tabulasi ada beberapa yang belum selesai jadi di lanjutkan dulu	h
14	1 Desember 2022	Penkodingan	Olah terlebih dahulu sampai Uji bivariat	h

15	27 Desember 2022	Konsul hasil output SPSS	Data yang dibagi menjadi 3 Fakultas digabung menjadi 1 saja	↓
16	2 Januari 2023	Konsul Bab III dan IV, V	Bab 3 Revisi soal penelitian & instrumen penelitian BAB 4 Revisi	↓

SKR : Hubungan dukungan sosial dengan ansietas pada mahasiswa

by Siti Citra Camila

Submission date: 20-Jul-2023 09:03AM (UTC+0800)

Submission ID: 2133794093

File name: SKRIPSI_FULLL_ACC.docx (1.07M)

Word count: 11525

Character count: 72646

SKR : Hubungan dukungan sosial dengan ansietas pada mahasiswa

ORIGINALITY REPORT

26% SIMILARITY INDEX	26% INTERNET SOURCES	7% PUBLICATIONS	9% STUDENT PAPERS
--------------------------------	--------------------------------	---------------------------	-----------------------------

PRIMARY SOURCES

1	dspace.umkt.ac.id Internet Source	4%
2	bppps.kemensos.go.id Internet Source	3%
3	repository.poltekkes-denpasar.ac.id Internet Source	2%
4	perawatqonaah.blogspot.com Internet Source	2%
5	Submitted to Universitas Sebelas Maret Student Paper	1%
6	eprints.mercubuana-yogya.ac.id Internet Source	1%
7	repository.uinjkt.ac.id Internet Source	1%
8	mahesainstitute.web.id Internet Source	1%
9	sinta.unud.ac.id Internet Source	1%